

16 degree Angled Pin Lever Care Handle

Chrome

Product Code: 181168

Product Specifications

Finish	Chrome
Materials	Zinc handle
Handle Reach	151mm
Suits	35mm cartridge mixers
Design	Lever handle for care facilities or those with restricted movement.
Inclusions	Handle Hot & Cold indicator Warm & Cold indicator
Maintenance and Care Instructions	Clean using a soft sponge or cloth with warm soapy water or detergent. Never use abrasive brushes or scourer pads to clean products. Rinse with water immediately after using any cleaning solution.

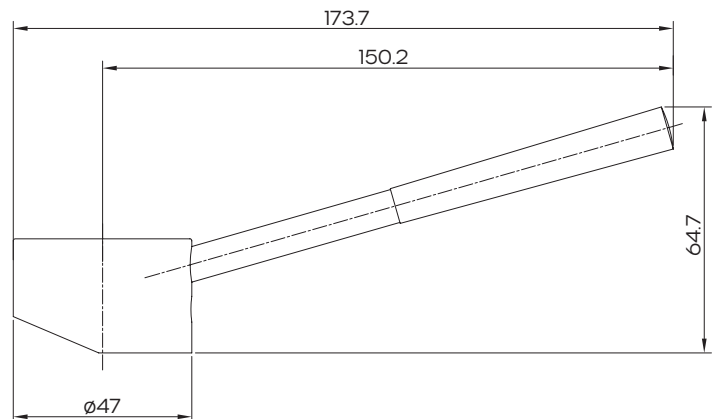
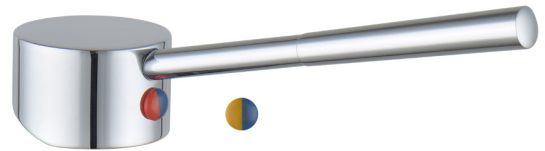

Limited Warranty
(visit raymor.com.au for full warranty details)

For more information call 1800 729 667 or visit raymor.com.au

© Registered trademark of Tradelink. All dimensions given are approximate and should be checked prior to installation. See raymor.com.au for full warranty details.

Raymor®