

Installation Instructions

150002/150022/202994 Sigma Tower Basin Mixer 4Star

Raymor

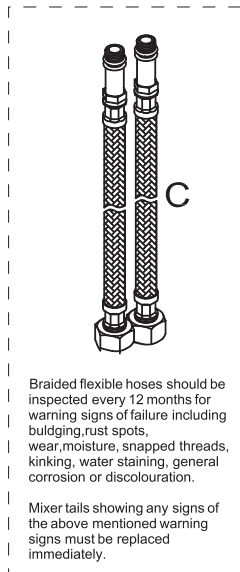
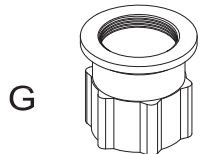
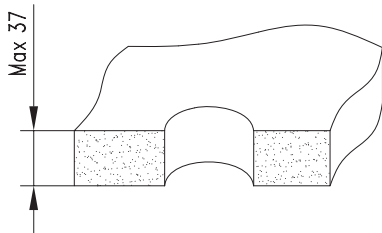
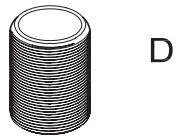
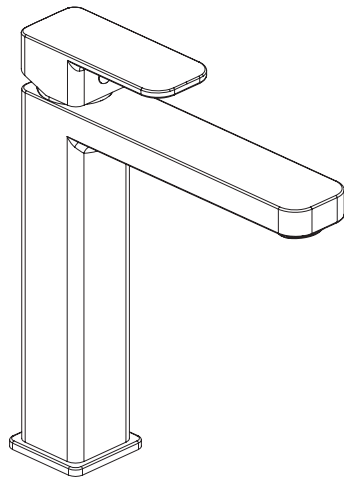

Important Information

This Product is to be installed by a licensed plumber, installation must comply with AS/NZS 3500 and relevant plumbing codes. Isolating stop taps are recommended to be fitted to the hot and cold inlet connections. Please leave this document with the Product after installation.

Please ensure that the lines are flushed prior to installation as contaminants in the water can damage the ceramic disc cartridge, O-rings and flow regulators and affect the performance of the Product. The WELS compliant aerator has been pre-assembled into the outlet (where applicable). To comply with WELS the flow regulated aerator must remain in place.

Before installation, remove Product from packaging and check the Product matches what you have ordered, is complete with all parts (per exploded drawing) and is not damaged. **If the Product is incorrect, damaged or missing parts DO NOT install and return to store** with proof of purchase for a refund or replacement. Installed Products are warranted for genuine manufacturing defects arising in your Product during the course of normal domestic or commercial use for the term of the warranty period. Our manufacturer's warranty does not cover Product which are incorrect or have been installed with pre-existing damage or missing parts.

Pressure & Temperatures

- Maximum Hydrostatic Pressure - 500kPa. (per AS/NZS3500.1 (Clause 3.3.4) which states "The maximum static pressure at any outlet, other than a fire service outlet, within a building shall not exceed 500kPa." **NB.** Pressures above 500kPa can cause damage from water hammer, reduced life of appliances, taps and fittings, and cause excessive noise in the system.
- Minimum Hydrostatic Pressure - 100kPa. This Product may not be suitable for use with a gravity fed water supply or with continuous flow or instantaneous hot water systems.
- Maximum operating temperature - 65°C.

Installation Instructions

NB. A single 35mm Hole is required in the mounting surface. The maximum mounting surface thickness cannot exceed 37mm.

1. Ensuring bench sealing washer (A) is in place on base of Mixer. **NB.** Some models will have a dress ring or dress plate and sealing washer (A) will be fitted to base of dress ring.
2. Feed Mixer Tail (C) male end first through Threaded Tube (D) Screw the Mixer tails (C) into base of the Mixer being careful to avoid damage to the O-ring seals, The Mixer tails are colour coded, Red for hot and Blue for cold, the Mixer base inlet holes are stamped with 'H' for Hot and 'C' for cold.
3. Screw Threaded Tube (D) into Mixer Base.
4. Feed the Mixer tails and Threaded Tube through the Mounting surface and position the Mixer on the mounting surface ensuring the sealing washer (A) is positioned correctly.
5. Slide Rubber Washer (E) onto threaded tube (D) followed by Metal Washer (F).
6. Using Fixing Nut (G) tighten Mixer to mounting Surface.
7. Connect Mixer tails to Mains Water supply line. We recommend the following guidelines when fitting flexible hoses:

DO NOT KINK



Minimum Bend Radius=72mm



DO NOT STRETCH

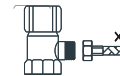

As a guide, a 300mm long hose should span a direct distance of 260-280mm between mixer base and plumbing supply connection

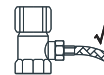

DO NOT TWIST

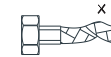

Avoid Twisting the hose. It should not be necessary to apply excessive force to the end fittings in order to obtain a watertight seal.



8. It is recommended that in-line filters be installed to ensure a cleaner flow of water to the Mixer.

Contact Details

Tradelink Pty Ltd
 ABN:29000003832
 Raymor Customer Care
 Ph: 1800 729 667
 1051 Nudgee Road Banyo QLD 4014
 customercare@raymor.com.au

Warranty Provider

Tradelink Pty Limited ABN 29 000 003 832 of 1051 Nudgee Rd Banyo QLD 4014 (Tradelink) offers warranties on each of the products set out in Schedule A (Product(s)) for the warranty periods specified, the details of which are set out in this document (Raymor Warranty). This Raymor Warranty supersedes and replaces any previous version of this document.

Raymor Warranty

This Raymor Warranty only covers the Products set out in Schedule A and does not extend to items that you have selected outside this range, including the items set out in Schedule B.

Subject to the terms and exclusions contained in this Raymor Warranty document, where a genuine manufacturing defect arises in your Product during the course of normal domestic use (or commercial use which is equivalent to normal domestic use) within the warranty period set out in Schedule A, Tradelink will, at its election repair the defect (without cost to you for labour or replacement parts) or replace the Product. Commercial Use is defined as all use other than for normal residential domestic purposes. Commercial Use includes use in non-business or non-commercial settings such as in public buildings, educational settings, not-for-profit organisations, sports centres, hotel rooms and home offices or in-home business settings).

The Raymor Warranty only applies to you if you are the original purchaser of the Product. It is not transferable.

Your Raymor Warranty commences from the date of purchase of your Product (or, for new buildings, on the date of handover) for the relevant period set out in Schedule A and is valid for purchases of Products made after the 1st March 2014. Your Raymor Warranty does not extend to the items set out in Schedule B and these items are sold with the warranty provided by the manufacturer, in addition to any rights and remedies you may have under the Australian Consumer Law. Please refer to the warranty document (if any) provided by the manufacturer named in Schedule B or contact the manufacturer for details.

Limitation of liability under Raymor Warranty

To the fullest extent permitted by law and subject to and without limiting your consumer rights under the Australian Consumer Law, Tradelink expressly limits its liability under this Raymor Warranty and under any other statutory guarantee imposed at law to, at its option:

- the replacement or repair of the Product;
- the supply of an equivalent Product; or
- the payment of the cost of the Product or of repairing the Product or of acquiring an equivalent Product.

In the event the Product is unavailable or unable to be supplied and a replacement is required, Tradelink reserves the right to supply a Product of equal quality, value and type at their discretion.

To the fullest extent permitted by law, Tradelink expressly excludes:

- all liability for damage or injury to any person;
- damage to any Property;
- loss of profit, loss of revenue, loss of use, loss of business, loss of opportunity, loss of goodwill, loss of contracts, loss of production, business interruption or any kind of indirect, special or consequential loss or damage arising in connection with the defective product;
- all conditions, warranties and undertakings in relation to the Products except as set out in this document.

SCHEDULE A: WARRANTY – PRODUCTS AND WARRANTY PERIODS

Raymor Product sold after 1st March 2014	
Category	Warranty Periods#
Mixers	20 years - mixer cartridge, mixer body, aerator, nylon braided TPSiV flexible hoses, spout, handle and chrome plated finish 10 years - handpieces and pull-down/out hoses, PVD and electroplate finishes 1 year - seals and labour
Three Piece Tapware	15 years - ceramic disc SBAs, spindle SBAs, body, spout, flanges, handles, aerators, fittings and chrome plated finish 5 years - PVD and electroplate finishes 1 year - seals, jumper valves and labour
Sinks & Tubs	25 years - sink & tub body 5 years - cabinet, wastes, clips, bypass kit, hoses 1 year - seals and labour
Toilets	20 years - vitreous china, nylon braided TPSiV flexible hoses and chrome plated finish 15 years - plastic cistern, in-wall cistern frame 5 years - inlet and outlet valves, toilet seat, link piece, flush pipe, flush button, PVD and electroplate finishes, fittings 1 year - seals and labour
Basins	20 years - vitreous china 5 years - plug and waste, overflow ring, bottle trap, chrome plated, PVD and electroplate finishes, fittings 1 year - seals and labour
Showers	20 years – main brass body, wall elbow, shower arm, shower rail, PVC coated hose, showerhead, handpiece, slide bracket, diverter assembly, soap dish, and chrome plated finish 5 years - PVD and electroplate finishes 1 year - seals and labour
Accessories	10 years - main body, chrome plated finish and fittings 5 years - PVD and electroplate finishes 1 year - seals and labour
Vanities	20 years - vitreous china top 10 years - polymarble top, cabinet, handles, runners, hinges 5 years - plug and waste, overflow ring and finishes 1 year - seals and labour

#For all clearance, ex-display and items sold "as-is" a fixed 12 month limited warranty is provided on parts and labour only, unless otherwise required by law.

SCHEDULE B: ITEMS COVERED BY A SEPARATE MANUFACTURER'S WARRANTY

Your Warranty does not extend to the items listed below and these items are sold with the warranty provided by the manufacturer, in addition to any rights and remedies you may have under the Australian Consumer Law. Please refer to the warranty document (if any) provided by the manufacturer named below or contact the manufacturer for details.

Category	Range	Manufacturer warranty provider
Vanities	Salt, Wentworth	Architectural Designer Products Pty Ltd
	Eco, Hampton	Marquis Bathroom Products Pty Ltd
	Outline, Ease, Stasis, Ocean	Showerama Products Pty Ltd
Water Filters	Filtration Systems	Puretec Pty Ltd
	Cartridges	Puretec Pty Ltd
Brass Cartridge Mixers	Banjo BC	Ramtaps Pty Ltd
Mixers	Alor, Lavas	Phoenix Industries Pty Ltd T/A Phoenix Tapware
Baths & Spa Baths	Aruba, Jamaica, Recline	Decina Bathroomware Pty Ltd
Shower Systems	Trinidad screens, walls	Decina Bathroomware Pty Ltd
	Trinidad, Luna shower bases	Decina Bathroomware Pty Ltd

How to make a warranty claim

To make a warranty claim, please contact Tradelink using the contact information contained in this Raymor Warranty document. No specific claim form is required however the following documentation must be supplied to Tradelink as part of your claim:

- Proof of purchase or handover documentation (for new homes);
- Your contact details, including the address of the installed Product; and
- A photo of your Product and the defect in question.

If the Product has not been installed, the Product can be returned with proof of purchase to the place of purchase. The cost of returning the Product is your responsibility; however, if the cost of returning any defective Product is unreasonable, please contact Tradelink on the telephone number listed below so that, if appropriate, we can arrange a collection. You must bear your own costs incurred in making a warranty claim.

If a Raymor Warranty service call finds that your Product does not have a genuine manufacturing defect, Tradelink reserves the right to charge you a service fee.

Tradelink requires reasonable and adequate access to Products, fittings and fixtures to undertake warranty repairs during normal weekday working hours. To the fullest extent permitted by law and subject to and without limiting your consumer rights under the Australian Consumer Law, Tradelink will not be responsible for any loss, damage or costs where reasonable and adequate access to Products, fittings and/or fixtures is not provided. Where parts or products are replaced or supplied under this warranty, the replacement parts or product shall be considered to be warranted from the date of purchase of the Product.

Tradelink reserves the right to provide you with minor components as 'parts only'.

Contact Information

Contact information for Tradelink is as follows:

Raymor Customer Care

Phone: 1800 RAYMOR (1800 729 667)

Email: customercare@raymor.com.au

1051 Nudgee Rd, BANYO QLD 4014

What is not covered

Your Raymor Warranty does not cover any defect or damage caused or partly caused, by or arising through: fair wear and tear (e.g. working seals in the inlet and outlet valves, scratching from cleaning, etc.); misuse, incorrect storage or handling of the Products; failure to correctly install, use or maintain the Product or to follow any instructions or guidelines for installation, use or maintenance of the Product; adverse environmental conditions; faulty design of a system in which the Products are used; the use of the Product otherwise than for any application specified on a quote or order form, price book or catalogue issued by Tradelink; the continued use of the Product after any defect becomes apparent or would have become apparent to a reasonably prudent operator or user; or any accident or act of God.

Your Raymor Warranty will be voided if any of the events detailed below arise:

– You are unable to provide proof of purchase or equivalent documentation from an authorised retailer of a Product;

– If:

- the Product is not installed by a licensed plumber and/or electrician;
- the Product is not installed in accordance with relevant Australian Standards, NCC and state regulations;
- the Product is not installed in accordance with the manufacturer's installation instructions;
- the water pressure exceeds stated limitations as per the Product installation instructions;
- the hot water system delivery temperature at the outlet exceeds 65 degrees Celsius;
- isolation stop taps are not fitted per AS/NZS 35–.5:2000 requirements for appliances and apparatus or the manufacturer's installation instructions;
- other devices are fitted to the outlet of tapware (e.g. water filters or stop valves);
- Tradelink non-approved parts are fitted in tap body or end of line water flow regulating devices;
- repair, service, alteration or replacement has been undertaken without the prior approval of Tradelink
- works are undertaken by a non-approved service agent or technician or where works are undertaken with non-standard or non-genuine replacement parts;
- inappropriate or non-approved connection fittings are used connecting Product to sewer;
- unauthorised modifications are made to Product;
- the Product is used for an incorrect application such as non-potable water, in commercial kitchens, restaurants, cafes, manufacturing facilities, etc.;
- the defect is a result of obstructions or damage due to inadequate flushing of system or problems caused by water supply (e.g. silt, thread tape, silicone, copper shavings, corrosion and excessive water pressure over 500kpa);
- the Product has all its components;
- there is a failure to regularly clean or replace dirty or blocked tapware aerator inserts and/or shower heads, etc.;
- there is a failure to regularly inspect flexible hoses for signs of failure including bulging, rust, wear, moisture, breaks, kinking, staining or discolouration;
- the removal or failure to install flow regulator in tapware or showers or regulated check valve or check valves in hand showers or veggie mixers;
- the Product is used with water additives (i.e. cleaning chemicals, disinfectants or additives in toilet cisterns);
- damage is caused to any surface, finish or protective coating by adhesives, sealants, etc.;
- damage is caused to any surface, finish or protective coating by an abrasive or harsh product (e.g. solvent, disinfectant, dye, bleach, oil, polish, acid, degreaser, alcohol, aerosol, etc.);
- exposure to ferrous metals or oxidants on stainless steel or chrome surfaces occurs (including substantial or prolonged exposure to cast iron, steel wool, bleach, hard water, etc.);
- installation or removal costs are incurred after the installation of Products which contained obvious or visible faults;
- damage caused to the Product from installation or post installation use, abuse or misuse;
- Product damage caused by misuse or abuse, as determined by a Tradelink Authorised Service Agent; or
- where a Product is coupled or used with a product other than a Product, the Raymor Warranty is limited only to the Product.

It is the responsibility of you and/or the installer to ensure that prior to installation:

- the Product is not damaged;
- you are happy with your purchase; and
- the Product has all its components.
- Following installation of your Product, it is your responsibility to ensure all required maintenance is performed.

Installed Products are warranted for genuine manufacturing defects arising in your Product during the course of normal domestic or equivalent commercial use for the term of the warranty period. Our manufacturer's warranty does not cover Product which are incorrect or have been installed with pre-existing damage or missing parts.

Australian Consumer Law

Our goods come with guarantees that cannot be excluded under the Australian Consumer Law. You are entitled to a replacement or refund for a major failure and compensation for any other reasonably foreseeable loss or damage. You are also entitled to have the goods repaired or replaced if the goods fail to be of acceptable quality and the failure does not amount to a major failure. This Raymor Warranty is in addition to your rights and remedies under the Australian Consumer Law.

Care Information

To ensure that you receive the longest lasting product life possible, we offer the following general advice to you for the care and maintenance of your Products:

- Regularly clean with warm, soapy water or detergent. Do not use caustic chemicals, aerosol sprays or cream cleansers.
- Use a soft, dampened sponge or cloth. Never use an abrasive brush, pad or cloth to clean your Products.
- Wipe surfaces clean and thoroughly rinse with water immediately after using any cleaner or solution.

Plastics, stainless steel, chrome finishes, vitreous china and polymarble Products are generally considered to be stain-resistant and durable but care should be taken in their use as they are not inherently stain-proof or scratch-proof. Vanity cabinets are manufactured from moisture-resistant materials but are not water-proof and care should be taken to wipe up spills and drips immediately.

Definitions and Interpretation

In these terms and conditions of warranty; "You" means the purchaser or customer acquiring the Goods and "Your" means belonging to you. "We" and "Us" means Tradelink as the manufacturer of the Goods and "Our" means belonging to Us. "Goods" means the goods You claim to be defective.