





Model Code: PR6

Included Accessories		
		
Inset Clip	6020	

Optional Accessories		
		
CBB400	RSSWB	

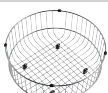
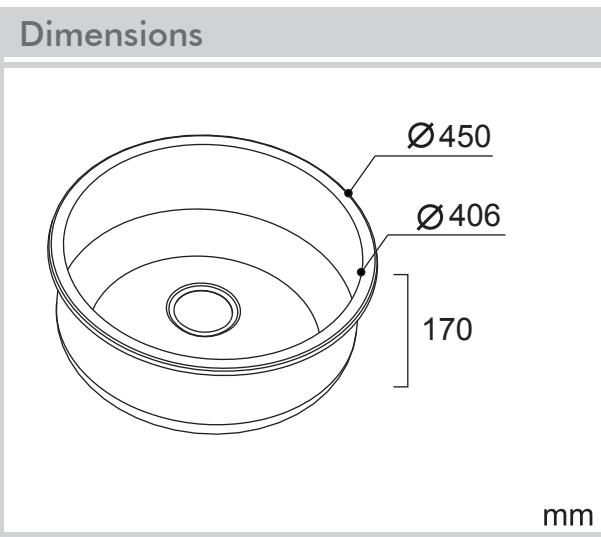



### Specifications

Description	Single bowl, inset sink
Overall Sink Size	450mm x 450mm x 170mm deep
Bowl Dimensions	406mm x 406mm x 170mm deep
Drainer Length	N/A
Technic	Pressed
Material	Stainless steel SUS304

### Installation

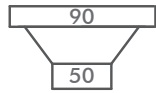
Fixings	Inset clips supplied
Template	N/A
Min Cabinet Size	476mm
Waste Holes	1 x 90mm round Compatible with waste disposal

<h4>SURFACE FINISH</h4>  <p>Mirror   Brushed</p>	<h4>WASTE KIT</h4> 	<h4>MATERIAL</h4>  <p>Stainless Steel</p>
---	--	--

### Plumbing

Waste Fittings	1 x (90mm x 2") basket waste included
Overflow	Available, conditions apply

<h4>INSTALLATION OPTIONS</h4>  <p>Inset</p>	<h4>PROFILE</h4>
--	------------------

### Packaging

Carton Type	EPS protection & individual carton
Gross Weight	1.89Kg
Carton Size	510mm x 505mm x 450mm
Pack QTY	5

Abey are Australia's leaders in sinkware, designing and manufacturing to the world's highest quality specifications as well as sourcing and bringing you Europe's very best, leading edge designs – practical, affordable, inspirational, stylish, timeless or cutting edge. When you buy an Abey stainless steel sink you receive the highest quality and 25 year warranty. Abey and the manufacturer are continually seeking ways to improve the design specifications, aesthetic and production techniques of the products. As a result, alterations to the specifications and dimensions of the products and designs occur continually.