

Nero

CELIA BASIN MIXER



SPECIFICATION

PRODUCT CODE	YSW3015-02
WELS RATING	5STAR 6L/MIN
WATERMARK LICENSE	WM-060073
TEMPERATURE RATING	MIN 1°C-MAX 75°C
PRESSURE RATING	MIN 150KPa-MAX 500KPa

FINISH

	NR301502CH	chrome
	NR301502MB	matte black
	NR301502BN	brushed nickel

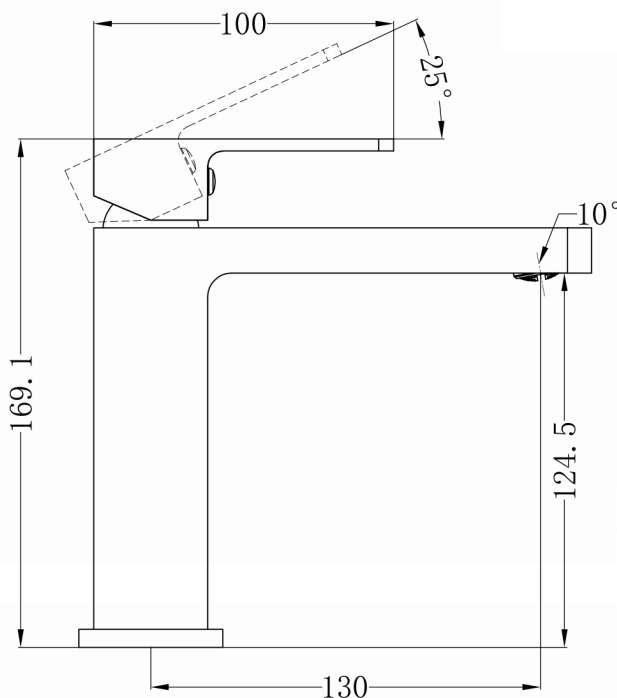

MAINTENANCE AND CARE

All surfaces should be cleaned with mild liquid detergent or soap and water.

Do not use cream cleaners or citrus based cleaning products, as they are abrasive.

Use of unsuitable cleaning agents may damage the surface. Any damage caused in this way will not be covered by warranty.

PACKAGING INCLUDES

- 1x basin mixer
- 1x base ring
- 2x flexible hose
- 1x installation kit

Dimensions are nominal measurements only.



Versions: 2021.06

www.nerotapware.com.au

INSTALL INSTRUCTION

IMPORTANT: Please read all of the instructions before installation.

General:

Nero recommends this product is installed by a licensed plumber in compliance with all relevant regional regulations.

Do not hydrostatic test the installation with this mixer installed. Damage to the ceramic cartridge may occur.

All pipe work must be thoroughly flushed prior to the installation of the mixer.

In-line filters must be fitted on both hot and cold supplies to prevent foreign particles damaging the ceramic cartridge.

Do not remove the ceramic cartridge from the mixer when installing.

After installation all connections must be checked for leaks.

All outlets used primarily for personal hygiene shall deliver water at a safe temperature as per regional regulations.

This mixer is not recommended for use in uncontrolled heating systems such as wet-backs or solar heating units unless a suitable tempering valve is fitted.

If limited water flow is experienced, locate aerator and filter washers and clean away foreign material as required.

It is the responsibility of the installer to ensure a waterproof seal is achieved between the product and mounting surface. If in doubt about the quality of the seal, remove the product and reinstall.

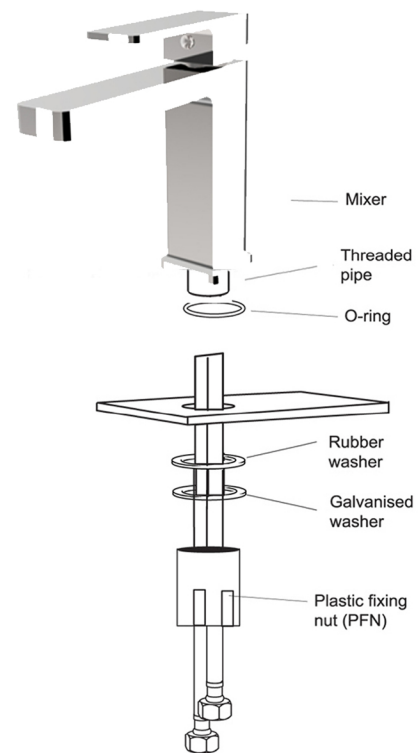

1. Fit the O-ring into the groove in the underside of the mixer body.
2. Screw the flexible hoses into the mixer body, and fully hand tighten.
3. Pass the tail of flexible pipes through the hole on the bench top from above, and place the mixer in position on the bench top. Inspect to see if any alteration to the existing supply pipe work is required. Make any necessary alterations.
4. Tighten the fixing nut to threaded pipes compressing the galvanized washer and rubber washer from the under-side of the counter.
5. Check that the mixer body is correctly positioned, fully tighten the fixing nut screw and fixing bolts firmly..
6. Connect the water supply pipes to the tail of flexible hoses with the hot water and cold water. Make sure the o-ring in the base ring seals completely around the hole in the mounting surface
7. Test for any leaks.