

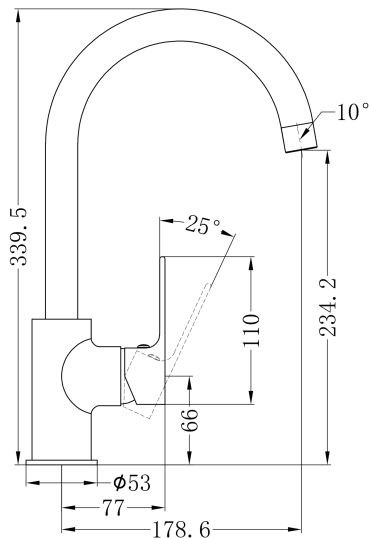





Bianca Kitchen Mixer



SPECIFICATION

PRODUCT CODE	YSW3215-06
WELS RATING	6Star 4.5L/Min
WATERMARK LICENSE	WM-060073
TEMPERATURE RATING	Min 1°C - Max 75°C
PRESSURE RATING	Min 150KPa - Max 500Kpa

AVAILABLE FINISH

	GUN METAL NR321506GM		BRUSHED NICKEL NR321506BN
	MATTE BLACK NR321506MB		BRUSHED GOLD NR321506BG
	CHROME NR321506CH		

MAINTENANCE AND CARE

All surfaces should be cleaned with mild liquid detergent or soap and water. Do not use cream cleaners or citrus based cleaning products, as they are abrasive. Use of unsuitable cleaning agents may damage the surface. Any damage caused in this way will not be covered by warranty.

PACKING INCLUDES

- 1x kitchen mixer
- 2x flexible hose
- 1x threaded pipe kit
- 1x allen key



IMPORTANT: Please read all of the instruction before installation.

General:

Nero recommends this product is installed by a licensed plumber in compliance with all relevant regional regulations. Do not hydrostatic test the installation with this mixer installed. Damage to the ceramic cartridge may occur. All pipe work must be thoroughly flushed prior to the installation of the mixer.

In-line filters must be fitted on both hot and cold supplies to prevent foreign particles damaging the ceramic cartridge. Do not remove the ceramic cartridge from the mixer when installing.

After installation all connections must be checked for leaks. All outlets used primarily for personal hygiene shall deliver water at a safe temperature as per regional regulations. This mixer is not recommended for use in uncontrolled heating systems such as wet-backs or solar heating units unless a suitable tempering valve is fitted.

If limited water flow is experienced, locate aerator and filter washers and clean away foreign material as required. It is the responsibility of the installer to ensure a waterproof seal is achieved between the product and mounting surface. If in doubt about the quality of the seal, remove the product and reinstall.

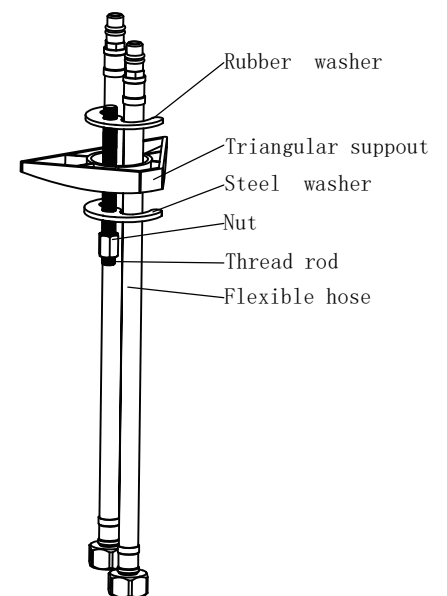
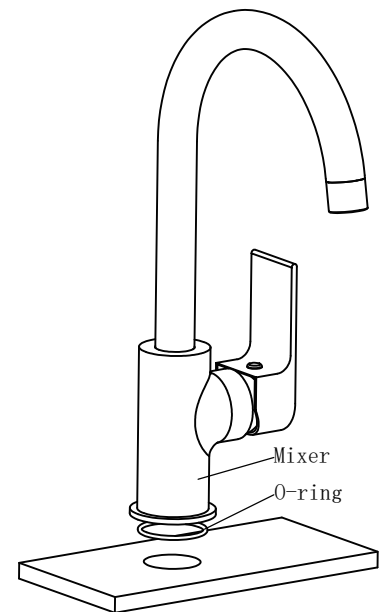

1. Screw Pin Screw into the mixer, and firmly tighten by tool.
2. Screw Flexi hoses into the mixer, and fully tighten by hand.
3. Position the base plate over the existing tap hole and make sure the O-ring is in the groove under the base plate.
4. Place the mixer onto the base plate.
5. Fit the rubber washer (and triangular support, if needed) then metal washer across the pin screw underneath the tap hole.
6. Firmly fasten the fixing nut onto the pin screw, and check mixer position if need to adjust.
7. Test and check for leaks.