





## Kara Progressive Basin Set

### SPECIFICATION

PRODUCT CODE	YSW2719-01
WELS RATING	6STAR 4.5L/MIN
WATERMARK LICENSE	WM-060073
TEMPERATURE RATING	MIN 1°C-MAX 75°C
PRESSURE RATING	MIN 150KPa-MAX 500KPa

### FINISH

	CHROME NR271901CH		MATTE BLACK NR271901MB
	BRUSHED NICKEL NR271901BN		GUN METAL NR271901GM
	BRUSHED GOLD NR271901BG		

### MAINTENANCE AND CARE

All surfaces should be cleaned with mild liquid detergent or soap and water.

Do not use cream cleaners or citrus based cleaning products, as they are abrasive.

Use of unsuitable cleaning agents may damage the surface. Any damage caused in this way will not be covered by warranty

### PACKING INCLUDES

- 1x basin spout
- 1x hand wheel
- 1x install kits

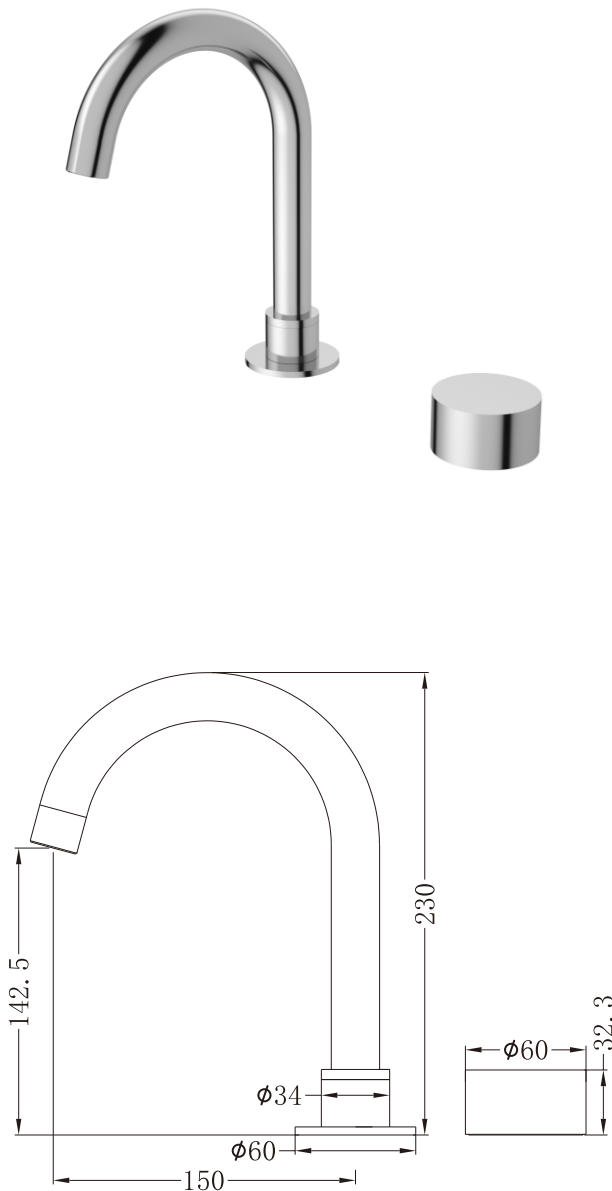

Dimensions are nominal measurements only.



## Installation Instruction

**IMPORTANT:** Please read all of the instruction before installation.

### General:

Nero recommends this product is installed by a licensed plumber in compliance with all relevant regional regulations.

Do not hydrostatic test the installation with this mixer installed. Damage to the ceramic cartridge may occur.

All pipe work must be thoroughly flushed prior to the installation of the mixer.

In-line filters must be fitted on both hot and cold supplies to prevent foreign particles damaging the ceramic cartridge.

Do not remove the ceramic cartridge from the mixer when installing.

After installation all connections must be checked for leaks.

All outlets used primarily for personal hygiene shall deliver water at a safe temperature as per regional regulations.

This mixer is not recommended for use in uncontrolled heating systems such as wet-backs or solar heating units unless a suitable tempering valve is fitted.

If limited water flow is experienced, locate aerator and filter washers and clean away foreign material as required.

It is the responsibility of the installer to ensure a waterproof seal is achieved between the product and mounting surface. If in doubt about the requality of the seal, remove the product and reinstall.

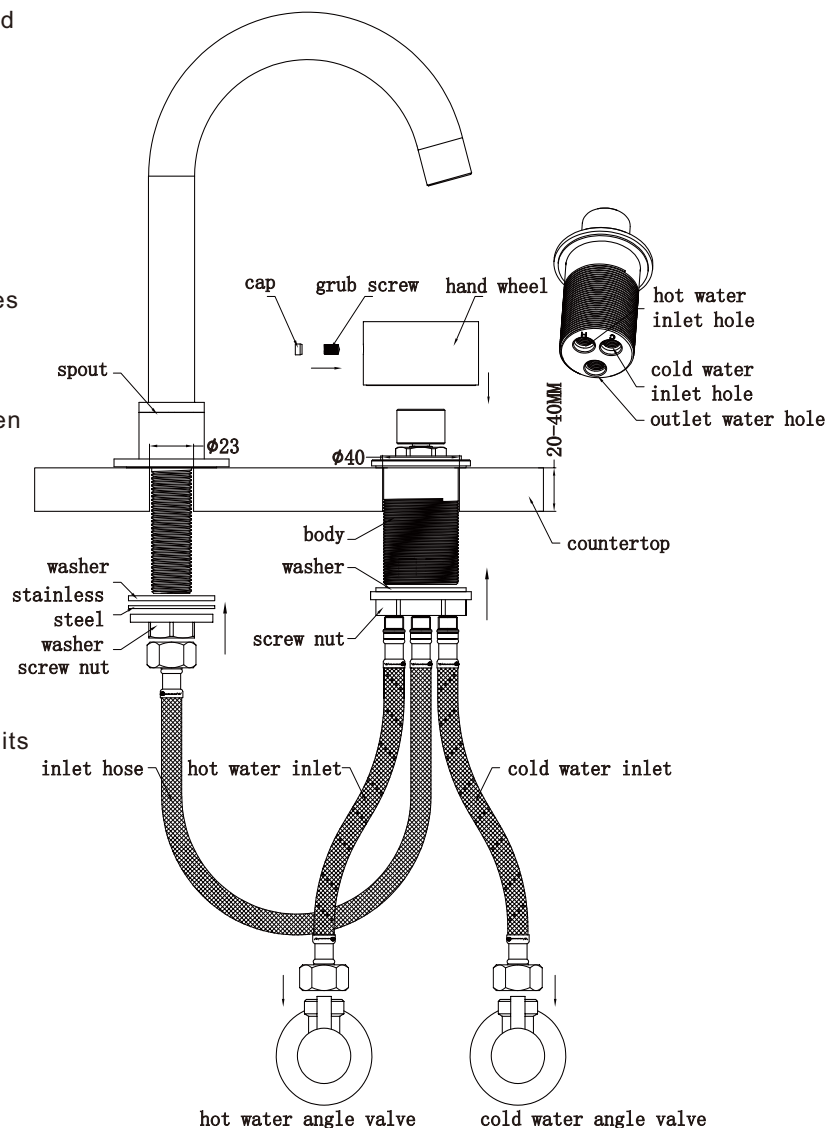

1. Please make sure the thickness of your countertop is within range 20-40mm before installation.
2. Drill a 23mm and a 40mm hole for spout and body according to the right picture.
3. Put body and spout into countertop and tighten the screw nut to threaded pipes compressing the rubber washer from the under-side of the counter.
4. Check that the mixer body is correctly positioned, fully tighten the screw nut firmly.
5. Connect flexible hoses according to the right picture.
6. Test for any leaks.