

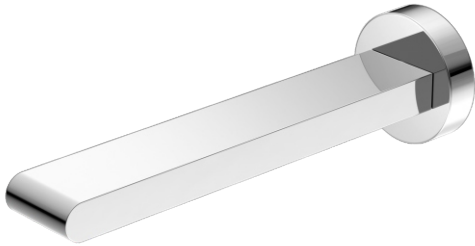





Bianca Fixed Basin/bath Spout 200mm



SPECIFICATION

WELS RATING	N/A
WATERMARK LICENSE	WM-060073
TEMPERATURE RATING	MIN 1°C-MAX 75°C
PRESSURE RATING	MIN 150KPa-MAX 500KPa

FINISH AND SKU

	CHROME NR321503CH		MATTE BLACK NR321503MB
	BRUSHED NICKEL NR321503BN		GUN METAL NR321503GM
	BRUSHED GOLD NR321503BG		

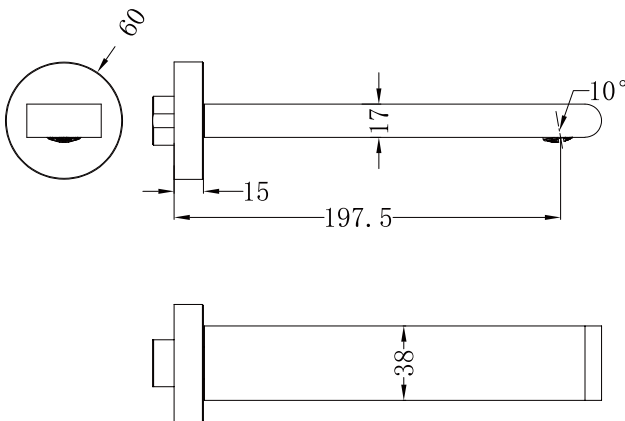

Dimensions are nominal measurements only.

MAINTENANCE AND CARE

All surfaces should be cleaned with mild liquid detergent or soap and water.

Do not use cream cleaners or citrus based cleaning products, as they are abrasive.

Use of unsuitable cleaning agents may damage the surface. Any damage caused in this way will not be covered by warranty.

PACKING INCLUDES

- 1x spout
- 1x plate



Installation Instruction



STEP1:
Cut off the G1/2 outlet thread, ensure the outlet thread needs 0-7mm protrude out of the finished wall.

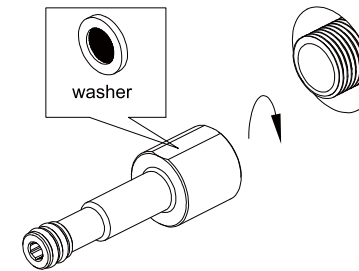

STEP 2
Turn the G1/2 spout adapter onto the outlet thread, and ensure to place the rubber washer inside, as shown in the figure.

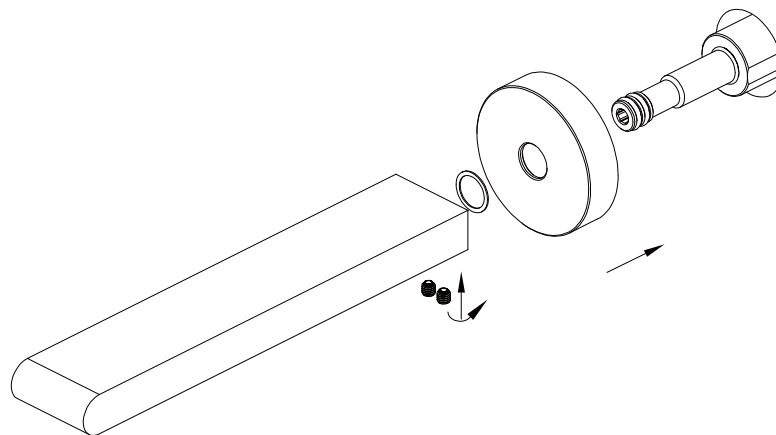

STEP3:

- o Fit the back plate onto the spout adapter.
- o Place the ABS washer against the backplate.
- o Push in the spout onto spout adapter, tighten two grub screws firmly on the underside of the spout with the Allen key. (Don't over tighten)

NOTE: Please level the spout to avoid residual water.