

*Owner's Guide
and
Installation Instructions*



*Electric Domestic
Water Heater*



*This water heater must be installed and serviced by a qualified person.
Please leave this guide with the householder.*

AQUAMAX AUSTRALIA PTY LIMITED, A.B.N. 37 138 189 689,
www.aquamax.com.au
For Service Telephone 131031 AUSTRALIA

An electronic copy of these Owner's Guide and Installation Instructions
can be downloaded from aquamax.com.au.

PATENTS

This water heater may be protected by one or more patents or registered designs
in the name of Aquamax Australia Pty Limited or Rheem Australia Pty Ltd.

TRADEMARKS

® Registered trademark of Aquamax Australia Pty Limited or Rheem Australia Pty Ltd.
™ Trademark of Aquamax Australia Pty Limited or Rheem Australia Pty Ltd.

Note: Every care has been taken to ensure the accuracy in preparation of this
publication. No liability can be accepted for any consequences
which may arise as a result of its application.

CONTENTS

HOUSEHOLDER

This booklet contains important information about your new water heater, including terms of the Aquamax warranty.

We recommend you read pages 8 to 25,
and the terms of the Aquamax warranty on pages 4 to 7.

The other pages are intended for the installer but may be of interest.

Warranty	4
Safety, Warnings, Installation Notes	8
About Your Water Heater	12
Maintenance Requirements	17
Water Supplies	19
Save A Service Call	23
Installation	26
Connections – Plumbing	35
Connections – Electrical	40
Commissioning	42
Draining The Water Heater	43

AQUAMAX ELECTRIC MAINS PRESSURE WATER HEATER WARRANTY - AUSTRALIA ONLY

ELECTRIC WATER HEATERS 971, 9W1, 991, 992 SERIES 160-400 MODELS

1. THE AQUAMAX WARRANTY – GENERAL

- 1.1 This warranty is given by Aquamax Australia Pty Limited ABN 37 138 189 689 of 463-467 Warrigal Road Moorabbin Victoria.
- 1.2 Aquamax offer a trained and qualified service network who will repair or replace components at the address of the water heater subject to the terms of the Aquamax warranty. Aquamax Service, in addition can provide preventative maintenance and advice on the operation of your water heater. The Aquamax Service contact number is 131031, with Contact Centre personnel available 24 hours, 7 days a week to take your call and if necessary to arrange a service call for during normal working hours Monday to Friday (hours subject to change).
- 1.3 For details about this warranty, you can contact us on 131031 or by email at service@aquamax.com.au (not for service bookings).
- 1.4 The terms of this warranty and what is covered by it are set out in sections 2 and 3 and apply to water heaters manufactured from 1st December 2018.
- 1.5 If a subsequent version of this warranty is published, the terms of that warranty and what is covered by it will apply to water heaters manufactured after the date specified in the subsequent version.

2. TERMS OF THE AQUAMAX WARRANTY AND EXCLUSIONS TO IT

- 2.1 Aquamax may reject a claim under this warranty in its sole discretion if:
 - a) You do not arrange for a major service to be conducted on your water heater in the fifth year after installation, in accordance with Aquamax's recommendation in the Owner's Guide and Installation Instructions; and
 - b) The fault giving rise to the warranty claim would have been detected and rectified during that major service.
- 2.2 The decision of whether to repair or replace a faulty component is at Aquamax's sole discretion.
- 2.3 If you require a call out and we find that the fault is not covered by the Aquamax warranty, you are responsible for our standard call out charge. If you wish to have the relevant component repaired or replaced by Aquamax, that service will be at your cost.
- 2.4 Where a failed component or cylinder is replaced under this warranty, the balance of the original warranty period will remain effective. The replacement does not carry a new Aquamax warranty.

AQUAMAX ELECTRIC MAINS PRESSURE WATER HEATER WARRANTY - AUSTRALIA ONLY

ELECTRIC WATER HEATERS 971, 9W1, 991, 992 SERIES 160-400 MODELS

- 2.5 Where the water heater is installed outside the boundaries of a metropolitan area as defined by Aquamax or further than 25 km from either a regional Aquamax branch office or an Accredited Aquamax Service Agent's office, the cost of transport, insurance and travelling between the nearest branch office or Aquamax Accredited Service Agent's office and the installed site shall be the owner's responsibility.
- 2.6 Where the water heater is installed in a position that does not allow safe or ready access, the cost of that access, including the cost of additional materials handling and/or safety equipment, shall be the owner's responsibility. In other words, the cost of dismantling or removing cupboards, doors or walls and the cost of any special equipment to bring the water heater to floor or ground level or to a serviceable position is not covered by this warranty.
- 2.7 This warranty only applies to the original and genuine Aquamax water heater in its original installed location and any genuine Aquamax replacement parts.
- 2.8 The Aquamax warranty does not cover faults that are a result of:
- a) Accidental damage to the water heater or any component (for example: (i) Acts of God such as floods, storms, fires, lightning strikes and the like; and (ii) third party acts or omissions).
 - b) Misuse or abnormal use of the water heater.
 - c) Installation not in accordance with the Owner's Guide and Installation Instructions or with relevant statutory and local requirements in the State or Territory in which the water heater is installed.
 - d) Connection at any time to a water supply that does not comply with the water supply guidelines as outlined in the Owner's Guide and Installation Instructions.
 - e) Repairs, attempts to repair or modifications to the water heater by a person other than Aquamax Service or an Aquamax Accredited Service Agent.
 - f) Faulty plumbing or faulty power supply.
 - g) Failure to maintain the water heater in accordance with the Owner's Guide and Installation Instructions.
 - h) Transport damage.
 - i) Fair wear and tear from adverse conditions (for example, corrosion).
 - j) Cosmetic defects.

AQUAMAX ELECTRIC MAINS PRESSURE WATER HEATER WARRANTY - AUSTRALIA ONLY

ELECTRIC WATER HEATERS 971, 9W1, 991, 992 SERIES 160-400 MODELS

- 2.9 Aquamax may reject a claim under this warranty in its sole discretion if a third party solar diverter is connected to the water heater.
- 2.10 Subject to any statutory provisions to the contrary, this warranty excludes any and all claims for damage to furniture, carpet, walls, foundations or any other consequential loss either directly or indirectly due to leakage from the water heater, or due to leakage from fittings and/ or pipe work of metal, plastic or other materials caused by water temperature, workmanship or other modes of failure.
- 2.11 If the water heater is not sized to supply the hot water demand in accordance with the guidelines in the Aquamax water heater literature, any resultant fault will not be covered by the Aquamax warranty.

3. WHAT IS COVERED BY THE AQUAMAX WARRANTY FOR THE WATER HEATERS DETAILED IN THIS DOCUMENT

- 3.1 Aquamax will repair or replace a faulty component of your water heater if it fails to operate in accordance with its specifications as follows:

What components are covered	The period from the date of installation in which the fault must appear in order to be covered	What coverage you receive
-----------------------------	--	---------------------------

971, 9W1, 991, 992 series 160-400 models

All components (all installations)	Year 1	Repair and/or replacement of the faulty component, free of charge, including labour.
The cylinder (if the water heater is installed in a single-family domestic dwelling)	Years 2 to 10	Replacement cylinder, free of charge. Installation and repair labour costs are the responsibility of the owner.

AQUAMAX ELECTRIC MAINS PRESSURE WATER HEATER WARRANTY - AUSTRALIA ONLY

ELECTRIC WATER HEATERS 971, 9W1, 991, 992 SERIES 160-400 MODELS

4. ENTITLEMENT TO MAKE A CLAIM UNDER THIS WARRANTY

- 4.1 To be entitled to make a claim under this warranty you need to:
- a) Be the owner of the water heater or have consent of the owner to act on their behalf
 - b) Contact Aquamax Service without undue delay after detection of the defect and, in any event, within the applicable warranty period.
- 4.2 You are not entitled to make a claim under this warranty if your water heater:
- a) Does not have its original serial numbers or rating labels.
 - b) Is not installed in Australia.

5. HOW TO MAKE A CLAIM UNDER THIS WARRANTY

- 5.1 If you wish to make a claim under this warranty, you need to:
- a) Contact Aquamax on 131031 and provide owner's details, address of the water heater, a contact number and date of installation of the water heater or if that's unavailable, the date of manufacture and serial number (from the rating label on the water heater).
 - b) Aquamax will arrange for the water heater to be tested and assessed on-site.
 - c) If Aquamax determines that you have a valid warranty claim, Aquamax will repair or replace the water heater in accordance with this warranty
- 5.2 Any expenses incurred in the making of a claim under this warranty will be borne by you.

6. THE AUSTRALIAN CONSUMER LAW

- 6.1 Our goods come with guarantees that cannot be excluded under the Australian Consumer Law. You are entitled to a replacement or refund for a major failure and for compensation for any other reasonably foreseeable loss or damage. You are also entitled to have the goods repaired or replaced if the goods fail to be of acceptable quality and the failure does not amount to a major failure.
- 6.2 The Aquamax warranty (set out above) is in addition to any rights and remedies that you may have under the Australian Consumer Law.

SAFETY, WARNINGS, INSTALLATION NOTES

It is important you read the following Safety and Warnings, and Relief Valves information.

SAFETY AND WARNINGS

- The water heater will operate until a water temperature of 60°C to 70°C is reached, depending upon the thermostat setting.

These temperatures are sufficiently hot to cause severe scalding. Water at these temperatures may have been plumbed to fixtures where water hotter than 50°C is allowed, such as the kitchen and laundry.

Refer to:

- “How Hot Should the Water Be?” on page 12, and
- “Hotter Water Increases the Risk of Scald Injury” on page 13, and
- “Temperature Adjustment” on page 13.
- This water heater is only intended to be operated by persons who have the experience or the knowledge and the capabilities to do so.
- This water heater is not intended to be operated by persons with reduced physical, sensory or mental capabilities i.e. the infirm, or by children. Children should be supervised to ensure they do not interfere with or play with or at the water heater.
- If the electrical conduit to the water heater is damaged, it must be replaced by a qualified person in order to avoid a hazard. Phone Aquamax Service to arrange for an inspection.
- This water heater uses 220 V – 240 V a.c. power for the electrically operated components. The removal of the front cover(s) will expose 220 V – 240 V a.c. wiring. It must only be removed by a qualified person. Do not operate the water heater with the cover(s) removed.
- This water heater is supplied with a thermostat, an over-temperature cut-out and a combination temperature pressure relief valve. These devices must not be tampered with or removed. The water heater must not be operated unless each of these devices is fitted and is in working order.

The Aquamax warranty may not cover faults if relief valves or other safety devices are tampered with or if the installation is not in accordance with these instructions.

- **DANGER:** The operation of the over-temperature cut-out on a thermostat indicates a possibly dangerous situation. If the over-temperature cut-out operates, it must not be reset, and the water heater must be serviced by a qualified person.

- The lever on the temperature pressure relief valve and expansion control valve (if fitted) requires to be operated every six (6) months to clear any deposits and to ensure the valve and its drain line are not blocked.

Refer to:

- “Relief Valves” on page 9, and
- “Minor Maintenance Every Six Months” on page 18.
- For continued safety of this water heater, it must be installed, operated and maintained in accordance with the Owner’s Guide and Installation Instructions.
- Servicing of a water heater must only be carried out by qualified personnel. Phone Aquamax Service.
- Only a person qualified to install or service a water heater can drain the water heater, if this is required.
- Do not modify this water heater.

RELIEF VALVES

Temperature Pressure Relief Valve

This water heater incorporates a temperature pressure relief valve located near the top of the water heater. This valve is essential for the water heater’s safe operation.

It is possible for the valve to discharge a quantity of water through the drain line during each heating period. This quantity should be equal to approximately 1/50 of the hot water used, as water expands by this volume when heated.

Expansion Control Valve

In many areas, including South Australia, Western Australia and scaling water areas, it is mandatory an expansion control valve is fitted to the cold water line to the water heater.

The expansion control valve will discharge the quantity of water from its drain line during the heating period instead of the temperature pressure relief valve as it has a lower pressure rating.

Valve Operation

Continuous leakage of water from either valve and its drain line may indicate a problem with the water heater. Refer to “Temperature Pressure Relief Valve or Expansion Control Valve Running” on page 24.

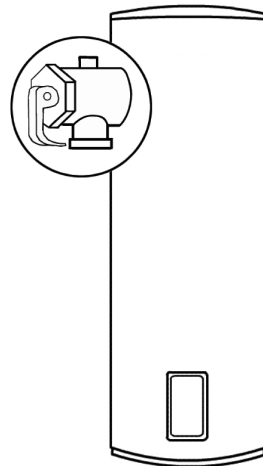

⚠ Warning: Never block the outlet of either valve or their drain lines for any reason. A relief valve drain must be left open to atmosphere and be installed in a continuously downward direction.

In locations where water pipes are prone to freezing, the relief valve drain line must be insulated and not exceed 300 mm in length before discharging into a tundish through an air gap.

Operate the easing lever on the temperature pressure relief valve and expansion control valve once every six (6) months to clear any deposits and ensure the valve and its drain line are not blocked. **It is very important the lever is raised and lowered gently.** Refer to “Minor Maintenance Every Six Months” on page 18.

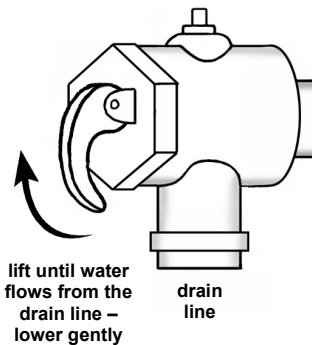

⚠ Warning: Water discharged from the temperature pressure relief valve drain line will be hot. Exercise care to avoid any splashing of water by standing clear of the drain line's point of discharge when operating either valve's easing lever.

⚠ DANGER: Failure to operate the easing lever on the relief valve once every six (6) months may result in the water heater cylinder failing, or under certain circumstances, exploding.

If water does not flow freely from the drain line when the lever is lifted, then the water heater must be checked. Phone Aquamax Service to arrange for an inspection.

The temperature pressure relief valve should be replaced at intervals not exceeding five (5) years and the expansion control valve should be checked for performance or replaced at intervals not exceeding five (5) years. The checking of the valves performance or replacement should occur more frequently in areas where there is a high incidence of water deposits. Refer to “Water Supplies” on page 19.

INSTALLATION NOTES

This water heater must be installed:

- by a qualified person,
- in accordance with the installation instructions,
- in compliance with the Plumbing Code of Australia (PCA) and Plumbing Standard AS/NZS 3500.4,
 - This water heater is designed for indoor or outdoor installation.

- This water heater is intended to be permanently connected to the water mains and not connected by a hose-set. A braided flexible hose or semi-flexible connector may be used for connection to the water heater, where permitted by AS/NZS 3500.4.
- in compliance with the Australian / New Zealand Wiring Rules AS/NZS 3000,
 - An isolation switch must be installed at the switchboard in the electrical circuit to the water heater in accordance with the Wiring Rules, so the water heater can be switched off. Refer to “Connections – Electrical” on page 40.
 - The power supply wires are to be directly connected to the terminal block and earth tab connection, with no excess wire loops inside the front cover. The temperature rating of the power supply wires insulation must suit this application, or the wiring protected by insulating sleeving with an appropriate temperature rating if it can make contact with the internal storage cylinder. The temperature of the internal storage cylinder can reach 70°C under normal operation.
- in compliance with all local codes and regulatory authority requirements,

Installation and commissioning requirements and details for the installing plumber and licensed electrical worker are contained on pages 26 to 42.

Mains pressure water supply

The water heater is designed to operate at mains pressure by connecting directly to the mains water supply.

The water heater is supplied with a temperature pressure relief valve. If an expansion control valve has been installed on the cold water line to the water heater, this should have a pressure rating as shown in the table below.

If the mains water supply pressure in your area exceeds that shown, an approved pressure limiting valve is required.

Models	971160	9W1160, & 250, 315, 400
Temperature pressure relief valve setting	1400 kPa	1000 kPa
Expansion control valve setting*	1200 kPa	850 kPa
Maximum mains supply pressure		
With expansion control valve	960 kPa	680 kPa
Without expansion control valve	1120 kPa	800 kPa

The supply pressure should be greater than 350 kPa for true mains pressure operation to be achieved.

ABOUT YOUR WATER HEATER

WATER HEATER APPLICATION

This water heater is designed for use in a single family domestic dwelling for the purpose of heating potable water. Its use in an application other than this may shorten its life.

MODEL TYPE

Aquamax® water heater models are available with either a single heating unit or with twin heating units (refer to “Single Element Model” on page 14 and “Twin Element Model” on page 14). The water heater is suitable for either indoor or outdoor installation.

Water is stored in a vitreous enamel lined steel cylinder and heated by the electric immersion heating unit. The thermostat controls the temperature. Automatic safety controls are fitted to the water heater to provide safe and efficient operation.

The water heaters have connections on either side of the tank. Plugs block off the alternative connection points. A 160 model has caps covering the plugs. The plugs and caps are not to be tampered with or removed.

HOW HOT SHOULD THE WATER BE?

The water heater features a tradesperson adjustable thermostat, which allows you to choose the most suitable temperature for your hot water needs. Refer to “Temperature Adjustment” on page 13.

To meet the requirements of the National Plumbing Standard the temperature of the stored water must not be below 60°C.

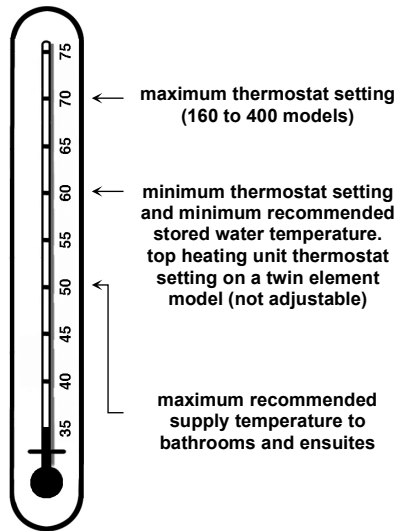

HOTTER WATER INCREASES THE RISK OF SCALD INJURY

⚠ Warning: This water heater can deliver hot water at temperatures up to 70°C depending upon the thermostat setting, sufficiently hot to cause severe scalding. Water at this temperature may have been plumbed to fixtures where water hotter than 50°C is allowed, such as the kitchen and laundry.

Check the water temperature before use, such as when entering a shower or filling a bath or basin, to ensure it is suitable for the application and will not cause scald injury.

We recommend and it may also be required by regulations that an approved temperature limiting device be fitted into the hot water pipe work to the bathroom and ensuite when this water heater is installed. This will keep the water temperature below 50°C at the bathroom and ensuite. The risk of scald injury will be reduced and still allow hotter water to the kitchen and laundry.

THERMOSTAT

The thermostat automatically controls the electricity supply to the heating unit so a constant temperature is maintained. The thermostat and its protective over temperature cut out is mounted inside the front cover of the water heater. There is no need to switch the water heater off when it is not in use, except when you are on an extended holiday. The thermostat is fully automatic and power is only used when heating is required.

TEMPERATURE ADJUSTMENT

The water heater features a tradesperson adjustable thermostat, which allows you to select the most suitable temperature for your hot water needs. This requires a licensed electrical worker to make any temperature adjustments. The thermostat has a maximum temperature setting of 70°C and a minimum temperature setting of 60°C.

We advise you to have a licensed electrical worker adjust the thermostat to the lowest temperature setting that meets your needs, especially if there are young children or elderly people in your home. Refer to “Hotter Water Increases the Risk of Scald Injury” on page 13.

SINGLE ELEMENT MODEL

This type of water heater has one heating unit with its own thermostat, located at the base of the water heater.

- **Continuous electricity supply**

This type of connection is suited to where the storage capacity is less than the normal daily usage.

- **Off-Peak electricity supply**

This type of connection will only allow heating to occur during set hours. A volume of water sufficient for the day's total use is heated and stored. This type of heating will be more economical due to reduced tariffs by the electricity authority.

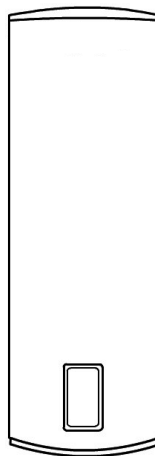

TWIN ELEMENT MODEL

This type of water heater has two heating units, each with its own thermostat. One heating unit is at the base of the water heater and the other near the top.

- **Bottom heating unit**

During normal operation this heating unit supplies all the hot water.

- **Top heating unit (Booster)**

This heating unit only operates during periods of high demand to provide an additional supply of heated water.

- **Electrical connection**

The two heating units are wired for non-simultaneous operation, so that only one heating unit can operate at a time. The bottom heating unit is usually connected to an Off-Peak (overnight) or time controlled supply and the top heating unit to a Continuous / Domestic supply. Some electricity suppliers allow both heating units to be metered at the Off-Peak or controlled tariff.

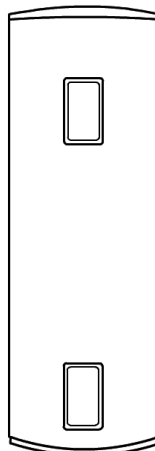

NOTE: Power must be available to the top heating unit circuit at all times for this water heater to operate as designed.

PRECAUTIONS

Where damage to property can occur in the event of the water heater leaking, the water heater must be installed in a safe tray. Construction, installation and draining of a safe tray must comply with AS/NZS 3500.4 and all local codes and regulatory authority requirements.

The water heater must be maintained in accordance with the Owner's Guide and Installation Instructions. Refer to "Maintenance Requirements" on page 17 and to "Anode Inspection and Replacement" on page 20.

If this water heater is to be used where an uninterrupted hot water supply is necessary for your application or business you should ensure that you have back-up redundancy within the hot water system design. This should ensure the continuity of hot water supply in the event that this water heater were to become inoperable for any reason. We recommend you seek advice from a plumber or specifier about your needs and building back-up redundancy into your hot water supply system.

TO TURN OFF THE WATER HEATER

If you plan to be away from home for only a few nights, we suggest you leave the water heater switched on.

If it is necessary to turn off the water heater:

- Switch off the electrical supply at the water heater isolating switch on the switchboard or at the isolating switch at the water heater (if installed).
- Close the cold water isolation valve at the inlet to the water heater.

TO TURN ON THE WATER HEATER

- Open the cold water isolation valve fully on the cold water line to the water heater.
- Switch on the electrical supply at the water heater isolating switch on the switchboard and at the isolating switch at the water heater (if installed).

GOING ON HOLIDAY?

If you plan to be away from home for one or two nights, we suggest you leave the water heater switched on. However, if you plan to stay away more than a few nights, conserve energy by switching the water heater off at either the switchboard or isolating switch (if one is installed).

Note: When the electrical supply is switched back on, the water heater will take some time to reheat the water. Depending upon the power supply connection, hot water may not be available until the next day.

VICTORIAN CUSTOMERS

Notice to Victorian Customers from the Victorian Building Authority. This water heater must be installed by a licensed person as required by the Victorian Building Act 1993.

Only a licensed person will give you a Compliance Certificate, showing that the work complies with all the relevant Standards. Only a licensed person will have insurance protecting their workmanship for 6 years. Make sure you use a licensed person to install this water heater and ask for your Compliance Certificate.

DOES THE WATER CHEMISTRY AFFECT THE WATER HEATER?

The water heater is suitable for most public water supplies, however some water chemistries may have detrimental effects on the water heater, its components and fittings. Refer to "Water Supplies" on page 19.

If you are in a known harsh water area or you are not sure of your water chemistry, have your water checked against the conditions described on pages 19 to 22.

HOW LONG WILL THE WATER HEATER LAST?

The water heater is supported by a manufacturer's warranty (refer to page 4). There are a number of factors that will affect the length of service the water heater will provide. These include but are not limited to the water chemistry, the water pressure, the water temperature (inlet and outlet) and the water usage pattern. Refer to "Precautions" on page 15.

MAINTENANCE REQUIREMENTS

MAJOR SERVICE EVERY FIVE YEARS

It is recommended a major service be conducted on the water heater every five (5) years.

⚠ Warning: Servicing of a water heater must only be carried out by qualified personnel. Phone Aquamax Service.

Note: The major service and routine replacement of any components, such as the anode and relief valve(s), are not included in the Aquamax warranty. A charge will be made for this work. Only genuine replacement parts should be used on this water heater.

The major service includes the following actions:

- Replace the temperature pressure relief valve.
- Inspect and flush the expansion control valve (if fitted). If required, replace the valve.
- Inspect and if required, replace the anode.

If the anode is not replaced, it should be replaced within five (5) years of this service (refer to “Anode Inspection and Replacement” on page 20).

- Check the electric heating unit for excessive calcium build-up or corrosion and replace if necessary.
- Visually check the unit for any potential problems.
- Inspect all connections.
- Check the drain line from the safe tray (if one is installed) is not blocked.

Note: The water heater may need to be drained during this service. After the completion of the service, the water heater will take some time to reheat the water. Depending upon the power supply connection, hot water may not be available until the next day.

MINOR MAINTENANCE EVERY SIX MONTHS

It is recommended minor maintenance be performed every six (6) months. Minor maintenance can be performed by the dwelling occupant.

The minor maintenance includes:

- Operate the easing lever on the temperature pressure relief valve. **It is very important the lever is raised and lowered gently.** Refer to “Relief Valves” on page 9.
⚠ Warning: Water discharged from the temperature pressure relief valve drain line will be hot. Exercise care to avoid any splashing of water by standing clear of the drain line’s point of discharge when operating the valve’s easing lever.
- Operate the easing lever on the expansion control valve (if fitted). **It is very important the lever is raised and lowered gently.** Refer to “Relief Valves” on page 9.
- Check the drain line from the safe tray (if one is installed) is not blocked.

WATER SUPPLIES

This water heater must be installed in accordance with this advice to be covered by the Aquamax warranty.

This water heater is manufactured to suit the water conditions of most public reticulated water supplies. However, there are some known water chemistries which can have detrimental effects on the water heater and its operation and / or life expectancy. If you are unsure of your water chemistry, you may be able to obtain information from your local water supply authority. This water heater should only be connected to a water supply which complies with these guidelines for the Aquamax warranty to apply.

ANODE

The vitreous enamel lined cylinder of the water heater is only covered by the Aquamax warranty when the total dissolved solids (TDS) content in the water is less than 2500 mg/L and when the correct colour coded anode is used. If an incorrect colour coded anode is used in the water heater, any resultant faults will not be covered by the Aquamax warranty. In addition, the use of an incorrect colour coded anode may shorten the life of the water heater cylinder.

The correct colour coded anode must be selected and fitted to the water heater in accordance with the following advice and the Anode Selection chart on page 20 for the Aquamax warranty to apply to the water heater cylinder.

Total Dissolved Solids	Anode colour code
0 – 40 mg/L	Green
40 – 150 mg/L	Green or Black
150 – 400 mg/L	Black
400 – 600 mg/L	Black or Blue
600 – 2500 mg/L	Blue
2500 mg/L +	Blue (no cylinder warranty)

The changing of anodes must be carried out by a qualified person.

Note: Some water analysis reports may state the conductivity of the water rather than the level of total dissolved solids. Conductivity, measured in microsiemens per centimetre ($\mu\text{S} / \text{cm}$), is directly proportional to the TDS content of the water. TDS, in mg / L, is approximately 70% of the conductivity in $\mu\text{S} / \text{cm}$.

40 (60)	150 (215)	400 (570)	600 (860)	TOTAL DISSOLVED SOLIDS (TDS) mg/L (CONDUCTIVITY - μ S/cm)	2500 (3570)
Green					
Black					
Blue					Blue
warranty applies to a vitreous enamel lined water heater cylinder if the correct coloured anode is used for the TDS / conductivity level of the water					above 2500 mg/L (3570 μ S/cm), no warranty applies to a vitreous enamel lined water heater cylinder

ANODE SELECTION

ANODE INSPECTION AND REPLACEMENT

The anode installed in your water heater will slowly dissipate whilst protecting the cylinder. The life of the cylinder may be extended by replacing the anode.

For water supplies which are either softened or desalinated, or where the water supply may alternate between a water tank and a reticulated public supply or another supply, or where there is a variable supply (e.g. from a bore or public reticulated supply from various water sources), the anode must be inspected (and replaced if there is any sign of depletion) within five (5) years of its installation, and within every three (3) years thereafter.

For all water supplies, if the anode is not replaced during a major service (refer to “Major Service Every Five Years” on page 17) then the maximum time after its installation when the anode should be replaced for this water heater is ten (10) years.

CAUTION

If the water supply has a TDS greater than 150 mg/L and a green anode has not been changed to a black anode, or if the TDS is greater than 600 mg/L and the anode has not been changed to a blue anode, there is the possibility the anode may become overactive and hydrogen gas could accumulate in the top of the water heater during long periods of no use.

If, under these conditions, the water heater has not been used for two or more weeks the following procedure should be carried out before using any electrical appliances (automatic washing machines and dishwashers) which are connected to the hot water supply.

The hydrogen, which is highly flammable, should be vented safely by opening a hot tap and allowing the water to flow. There should be no smoking or naked flame near the tap whilst it is turned on. Any hydrogen gas will be dissipated. This is indicated by an unusual spurting of the water from the tap. Once the water runs freely, any hydrogen in the system will have been released.

SATURATION INDEX

The saturation index is used as a measure of the water’s corrosive or scaling properties. The saturation index figures stated are calculated using a water temperature of 80°C.

In a corrosive water supply, the water can attack copper parts and cause them to fail. Where the saturation index is less than -1.0, the water is very corrosive and the Aquamax warranty does not apply to a copper sheathed heating unit. A corrosion resistant heating unit must be used for the Aquamax warranty to apply to the heating unit.

In a scaling water supply calcium carbonate is deposited out of the water onto any hot metallic surface. Where the saturation index exceeds +0.40, the water is very scaling. An expansion control valve must be fitted on the cold water line after the non-return valve to protect and for the Aquamax warranty to apply to the temperature pressure relief valve and water heater cylinder.

Where the saturation index exceeds +0.80, the Aquamax warranty does not apply to a standard watts density heating unit. A low watts density heating unit must be used for the Aquamax warranty to apply to the heating unit.

Water which is scaling may be treated with a water softening device to reduce the saturation index of the water.

Refer to the Saturation Index chart on page 21. Refer to the cold water connection detail on page 35 for the position of the expansion control valve.

Contact Aquamax Service if a replacement heating unit is required.

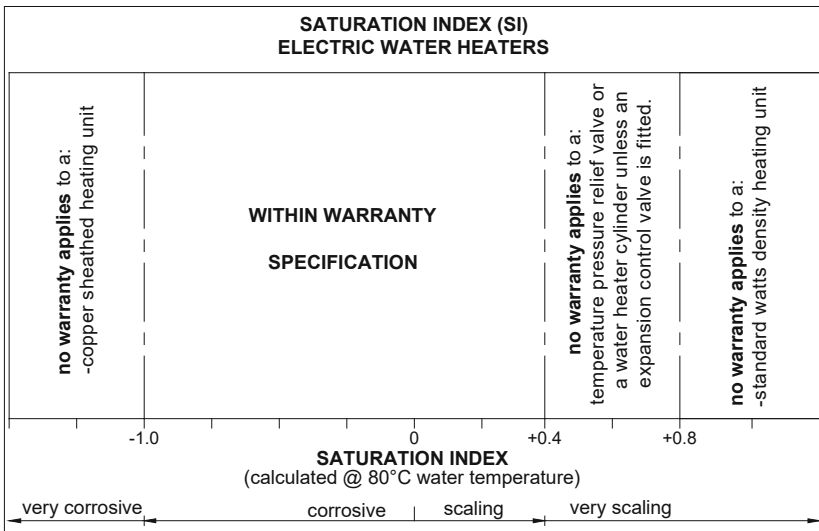

CHANGE OF WATER SUPPLY

The changing or alternating from one water supply to another can have a detrimental effect on the operation and / or life expectation of a water heater cylinder, a temperature pressure relief valve and a heating unit.

Where there is a changeover from one water supply to another, e.g. a rainwater tank supply, bore water supply, desalinated water supply, public reticulated water supply or water brought in from another supply, then water chemistry information should be sought from the supplier or it should be tested to ensure the water supply meets the requirements given in these guidelines for the Aquamax warranty to apply.

SUMMARY OF WATER CHEMISTRY ADVICE AFFECTING WARRANTY

The water heater and its components are not suitable for certain water chemistries. Those chemistries are listed below. If the water heater is connected at any time to a water supply with the following water chemistry, the Aquamax warranty will not cover any resultant faults on the components listed below:

Water Chemistry	Component
Total Dissolved Solids (TDS) > 2500 mg/L	water heater cylinder
Total Dissolved Solids (TDS) not suitable for anode type	water heater cylinder
Saturation Index (SI) < -1.0	copper sheathed heating unit
Saturation Index (SI) > +0.4 (if expansion control valve is not fitted)	water heater cylinder temperature pressure relief valve
Saturation Index (SI) > +0.8	standard watts density heating unit

SAVE A SERVICE CALL

Check the items below before making a service call. You will be charged for attending to any condition or fault that is not related to the manufacture or failure of a part.

NOT ENOUGH HOT WATER (OR NO HOT WATER)

- **Is the electricity switched on?**

Inspect the isolating switch marked “HOT WATER” or “WATER HEATER” at the switchboard and the isolating switch (if one is installed) near the water heater and ensure they are turned on.

Note: Check the electricity supply to which the water heater is connected. If on an Off-Peak or time controlled electricity supply, remember heating hours are restricted.

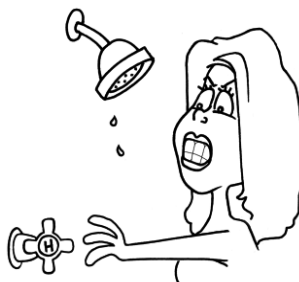

Refer to “Off-Peak Electricity Supply” on page 14.

- Check the fuse or circuit breaker marked “HOT WATER” or “WATER HEATER” at the switchboard.

- **Twin element water heaters**

A twin element non-simultaneous model must have power available to the top heating unit circuit at all times for the water heater to operate as designed.

- **Are you using more hot water than you think?**

Is one outlet (especially the shower) using more hot water than you think?

Very often it is not realised the amount of hot water used, particularly when showering. Carefully review the family’s hot water usage. Have a plumber fit a flow control valve to each shower outlet to reduce water usage.

- **Relief valve running**

Is the relief valve discharging too much water?

Refer to “Temperature Pressure Relief Valve or Expansion Control Valve Running” on page 24.

- **Thermostat setting**

Ensure the thermostat setting is appropriate. You may choose to have a licensed electrical worker check and adjust the thermostat upwards to gain additional hot water capacity.

Refer to “Temperature Adjustment” on page 13.

⚠ Warning: Hotter water increases the risk of scald injury.

- **Water heater size**

Do you have the correct size water heater for your requirements?

The sizing guide in the Aquamax sales literature suggests average sizes that may be needed.

TEMPERATURE PRESSURE RELIEF VALVE OR EXPANSION CONTROL VALVE RUNNING

- **Normal Operation**

It is normal and desirable the temperature pressure relief valve or expansion control valve (if fitted) allows a quantity of water to escape during the heating cycle. This quantity should be equal to approximately 1/50 of the hot water used, as water expands by this volume when heated. However, if it discharges more than a bucket full of water in 24 hours, there may be another problem.

The expansion control valve will discharge water instead of the temperature pressure relief valve as it has a lower pressure rating. A benefit is that energy is conserved as the discharged water is cooler. This valve is installed in the cold water line to the water heater (refer to the cold water connection diagram on page 35).

- **Continuous dribble**

Try gently raising the easing lever on the relief valve for a few seconds (refer to "Relief Valves" on page 9). This may dislodge a small particle of foreign matter and clear the fault. Release the lever gently.

- **Steady flows for long period (often at night)**

This may indicate the mains water pressure sometimes rises above the designed pressure of the water heater. Ask your installing plumber to fit a pressure limiting valve.

⚠ Warning: Never replace the relief valve with one of a higher pressure rating.

- **Heavy flows of hot water from the temperature pressure relief valve until water heater is cold - then stops until water reheats**

The water heater **must** be switched off at the switchboard. Phone Aquamax Service to arrange for inspection.

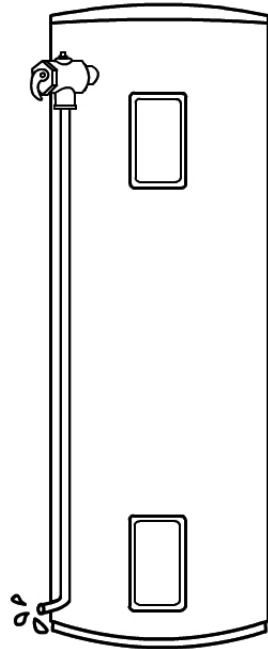

HIGHER THAN EXPECTED ELECTRICITY BILLS

Should you at any time, feel your electricity bill is higher than expected, we suggest you check the following points:

- Is the relief valve running excessively?

Refer to “Temperature Pressure Relief Valve or Expansion Control Valve Running” on page 24.

- Is one outlet (especially the shower) using more hot water than you think?

Refer to “Not Enough Hot Water” on page 23.

- Is there a leaking hot water pipe, dripping hot water tap, etc?

Even a small leak will waste a surprising quantity of hot water and electricity. Replace faulty tap washers, and have a plumber rectify any leaking pipe work.

- Has there been an increase in hot water usage?

An increase in hot water usage will result in an increase in water heater operation.

- Has your water heating tariff rate been increased by your electricity retailer since your previous bill?

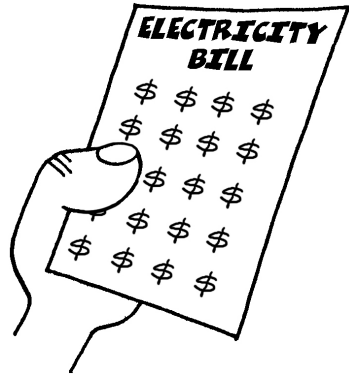

ELECTRICITY TARIFFS

The electricity tariff to which your water heater is connected will determine the overall operating cost of the system. It is important you are aware of this tariff, i.e. Off-Peak (overnight) or time controlled supply, Extended Off-Peak (overnight and day) or Extended time controlled supply, Domestic or Continuous supply. For types of tariffs, refer to “Single Element Model” on page 14 and “Twin Element Model” on page 14.

IF YOU HAVE CHECKED ALL THE FOREGOING AND STILL BELIEVE YOU NEED ASSISTANCE, PHONE AQUAMAX SERVICE.

INSTALLATION

THIS WATER HEATER IS NOT SUITABLE FOR POOL HEATING

INSTALLATION STANDARDS

The water heater must be installed:

- by a qualified person, and
- in accordance with the installation instructions, and
- in compliance with the Plumbing Code of Australia (PCA), Standards AS/NZS 3500.4 and AS/NZS 3000, and all local codes and regulatory authority requirements.

⚠ Warning: This water heater may deliver water at high temperature. Refer to the Plumbing Code of Australia, local requirements and these installation instructions to determine if additional delivery temperature control is required. Refer to “Hot Water Delivery” on page 29.

All packaging materials must be removed from the water heater prior to its installation. This includes the removal of the cardboard base of the carton from the underside of the water heater.

WATER HEATER APPLICATION

This water heater is designed for use in a single family domestic dwelling for the purpose of heating potable water. Its use in an application other than this may shorten its life.

If this water heater is to be used where an uninterrupted hot water supply is necessary for the application or business, then there should be back-up redundancy within the hot water system design. This should ensure the continuity of hot water supply in the event that this water heater was to become inoperable for any reason. We recommend you provide advice to the system owner about their needs and building back-up redundancy into the hot water supply system.

WATER HEATER LOCATION

The water heater is suitable for either indoor or outdoor installation. Whether located outdoor or indoor, the water heater should be installed close to the most frequently used outlet and its position chosen with safety and service in mind.

Clearance must be allowed for servicing of the water heater. The water heater must be accessible without the use of a ladder or scaffold. Make sure the temperature pressure relief valve lever is accessible and the front cover, thermostat and heating unit can be removed for service.

You must be able to read the information on the rating plate. If possible leave headroom of one water heater height so the anode can be inspected or replaced. Remember you may have to take the entire water heater out later for servicing.

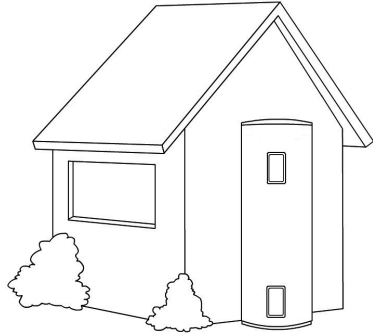

The water heater is to be installed at ground or floor level and must stand vertically upright on a stable base as acceptable to local authorities. The base of the water heater is made of corrosion resistant material, and it may be placed directly in contact with the supporting surface. It is not necessary to allow for free air circulation under the base of the water heater.

Note: The water heater should not be placed in direct contact with a concrete surface that is less than two months old and not fully cured as this may attack the metal coating of the water heater base. A moisture barrier should be used between the two surfaces in this instance. The barrier should extend at least 100 mm from the water heater and may be trimmed after two months.

Remember all local authorities have regulations about putting water heaters into roof spaces.

SAFE TRAY

Where damage to property can occur in the event of the water heater leaking, the water heater must be installed in a safe tray. Construction, installation and draining of a safe tray must comply with AS/NZS 3500.4 and all local codes and regulatory authority requirements. AS/NZS 3500.4 also has particular requirements when a safe tray must be installed.

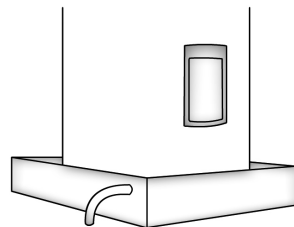

MAINS WATER SUPPLY

Where the mains water supply pressure exceeds that shown in the table below, an approved pressure limiting valve is required and should be fitted as shown in the cold water connection diagram on page 35.

Model	971160	9W1160, & 250, 315, 400
Temp press relief valve setting	1400 kPa	1000 kPa
Expansion control valve setting*	1200 kPa	850 kPa
Maximum mains supply pressure		
With expansion control valve	960 kPa	680 kPa
Without expansion control valve	1120 kPa	800 kPa

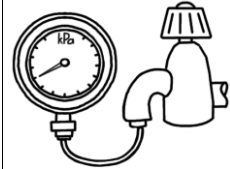

* Expansion control valve not supplied with water heater

TANK WATER SUPPLY

If the water heater is supplied with water from a tank supply and a pressure pump system is not installed, then the bottom of the supply tank must be at least 1 m above the highest point of the hot water plumbing system, including the water heater. Care must be taken to avoid air locks. The cold water line to the water heater should be adequately sized and fitted with a full flow gate valve or ball valve.

ANODE

The vitreous enamel lined cylinder of the water heater is only covered by the Aquamax warranty when the total dissolved solids (TDS) content in the water is less than 2500 mg/L and when the correct colour coded anode is used. If an incorrect colour coded anode is used in the water heater, any resultant faults will not be covered by the Aquamax warranty. In addition, the use of an incorrect colour coded anode may shorten the life of the water heater cylinder.

The correct colour coded anode for the water supply being used must be selected and fitted to the water heater for the Aquamax warranty to apply to the water heater cylinder (refer to “Water Supplies” on page 19 and the Anode Selection table on page 19). The black anode is typically fitted as standard.

If an incorrect anode is used, there is also the possibility the anode may become overactive and hydrogen gas could accumulate in the top of the water heater during long periods of no use. In areas where this is likely to occur, the installer should instruct the householder on how to dissipate the gas safely (refer to “Caution” on page 20).

HOT WATER DELIVERY

⚠ Warning: This water heater can deliver hot water at temperatures up to 70°C, sufficiently hot to cause severe scalding. Water at this temperature may be plumbed to fixtures where water hotter than 50°C is allowed, such as the kitchen and laundry.

The installing plumber may have a legal obligation to ensure the installation of this water heater meets the water temperature delivery requirements of the Plumbing Code of Australia so that heated water delivered to fixtures and appliances used primarily for personal hygiene is at a temperature which is unlikely to scald.

It is necessary and we recommend that a temperature limiting device be fitted between the water heater and the fixtures and appliances used primarily for personal hygiene such as in a bathroom, ensuite, public amenities or other ablution areas, to reduce the risk of scalding.

Where a temperature limiting device is installed adjacent to the water heater, the cold water line to the temperature limiting device can be branched off the cold water line either before or after the isolation valve, pressure limiting valve and non-return valve to the water heater. If an expansion control valve is required, it must always be installed after the non-return valve and be the last valve prior to the water heater.

If a pressure limiting valve is installed on the cold water line to the water heater and the cold water line to a temperature limiting device branches off before this valve or from another cold water line in the premises, then a pressure limiting valve of an equal pressure setting may be required prior to the temperature limiting device.

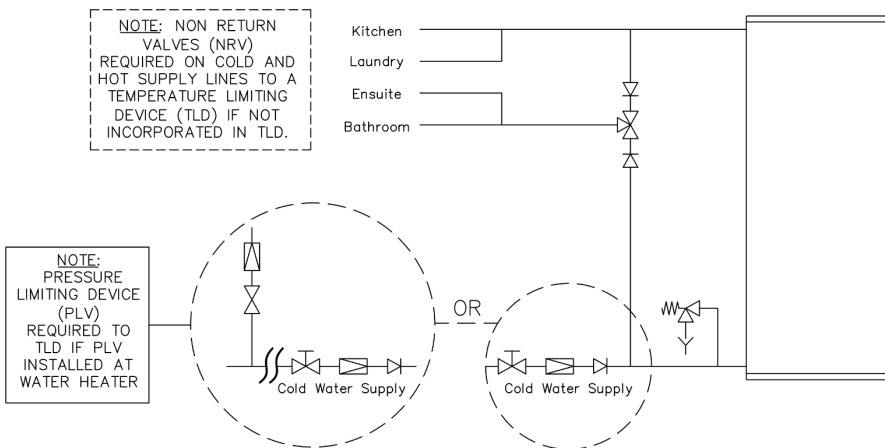

Two Temperature Zones Using a Temperature Limiting Device

CIRCULATED HOT WATER FLOW AND RETURN SYSTEM

If an Aquamax water heater is to be installed as part of a circulated hot water flow and return system, it must be able to provide a hot water outlet temperature of at least 60°C. **Note:** The thermostat must always be set to at least 60°C.

Refer to the Circulated Hot Water Flow and Return – Continuous Electric Water Heater diagram on page 30.

Temperature Limiting Device

A temperature limiting device cannot be installed in circulated hot water flow and return pipe work. The tempered water from a temperature limiting device cannot be circulated. Where a circulated hot water flow and return system is required in a building, a temperature limiting device can only be installed on a dead leg, branching off the circulated hot water flow and return pipe.

If circulated tempered water were to be returned back to the water heater, depending on the location of the return line connection on the water supply line to the water heater, then either:

- water will be supplied to the cold water inlet of the temperature limiting device at a temperature exceeding the maximum recommended water supply temperature, or
- when the hot taps are closed no water will be supplied to the cold water inlet of the temperature limiting device whilst hot water will continue to be supplied to the hot water inlet of the temperature limiting device.

These conditions may result in either water at a temperature exceeding the requirements of AS/NZS 3500.4 being delivered to the hot water outlets in the ablution areas, or the device closing completely and not delivering water at all, or the device failing. Under either condition, the operation and performance of the device cannot be guaranteed.

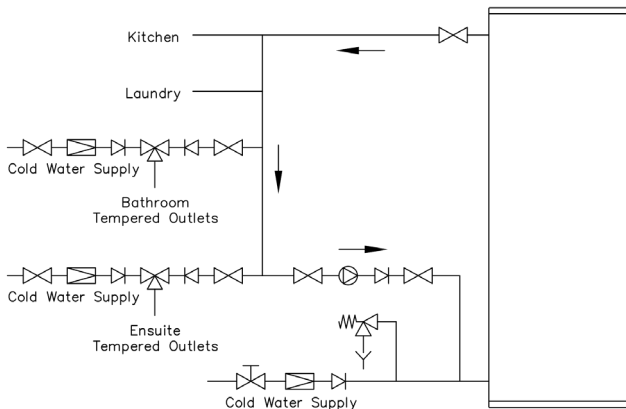

Circulated Hot Water Flow and Return – Continuous Electric Water Heater

Off-Peak or Time Controlled Electricity Supply

A single or twin element electric water heater connected to an Off-Peak electricity supply should not be installed as part of a circulated hot water flow and return system in a building. The benefits of the Off-Peak electricity supply will be significantly reduced.

If a circulated flow and return system is required, it is necessary to install a secondary water heater supplied from the Off-Peak electric water heater. The flow and return lines connect to the secondary water heater, not the Off-Peak electric water heater. The secondary water heater makes up for the pipe heat loss in the flow and return system and must be able to provide a hot water outlet temperature of at least 60°C.

Note: The thermostat or preset outlet temperature of the secondary water heater must always be set to maintain a temperature at least 60°C in the hot water flow and return line, including making up pipe heat losses in the system.

Refer to the Circulated Hot Water Flow and Return – Off-Peak Electric Water Heater diagram on page 31.

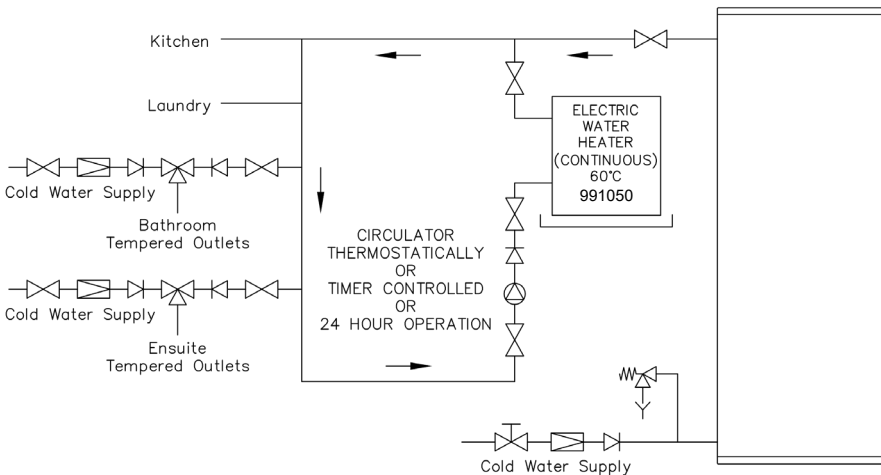

NOTE: A PLV IS REQUIRED TO BE INSTALLED ON THE COLD SUPPLY LINE TO THE TEMPERING VALVE IF A PLV IS INSTALLED ON THE COLD SUPPLY LINE TO THE WATER HEATER.

**Circulated Hot Water Flow and Return
Off-Peak Electric Water Heater**

REDUCING HEAT LOSSES

The cold water line to and the hot water line from the water heater must be insulated in accordance with the requirements of AS/NZS 3500.4. The insulation must be weatherproof and UV resistant if exposed.

SADDLING PIPE WORK

To prevent damage to the cylinder when attaching pipe clips or saddles to the water heater jacket, we recommend the use of self-drilling screws with a maximum length of 13 mm. Should pre-drilling be required, extreme caution must be observed when penetrating the jacket of the water heater.

Note: If the cylinder is damaged as a result of attaching pipe clips or saddles to the jacket, any resultant faults will not be covered by the Aquamax warranty.

TYPICAL INSTALLATION – OUTDOOR LOCATION

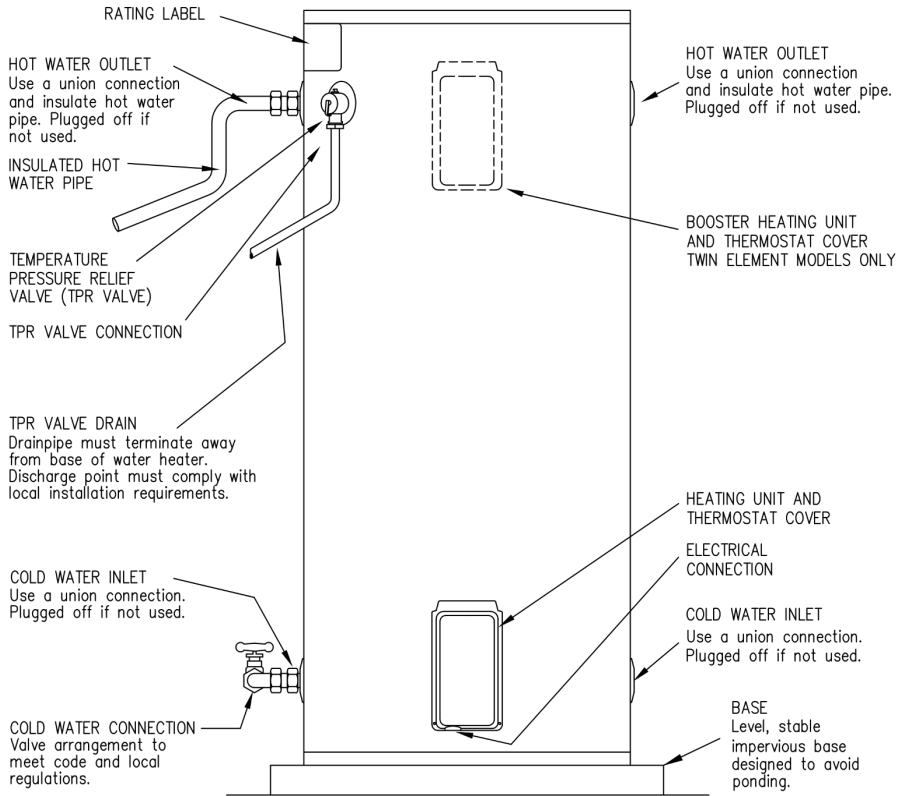

TYPICAL INSTALLATION – INDOOR LOCATION

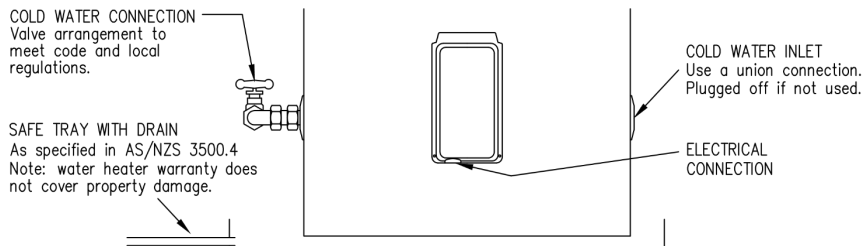

DIMENSIONS AND TECHNICAL DATA – 160 TO 400 MODELS

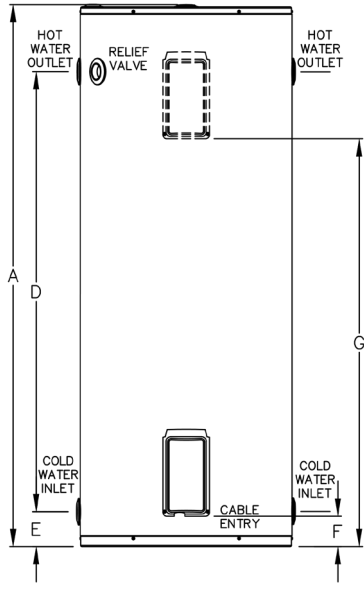
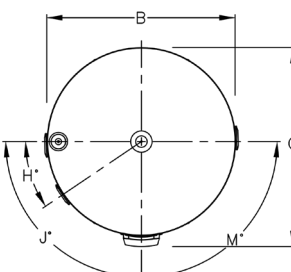
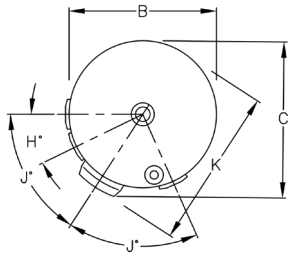

Single Element	DH	971160	9W1160	991250	991315	991400	
Twin Element	DH	-	-	992250	992315	992400	
Hot Water Delivery	Litres	160	160	250	315	400	
Boost Capacity	Litres	-	-	50	50	90	
Dimensions	A	mm	1610	965	1395	1640	1840
	B	mm	480	640	640	640	690
	C	mm	500	680	680	680	730
	D	mm	1332	642	1112	1317	1479
	E	mm	104	113	73	113	121
	F	mm	66	103	103	103	105
	G	mm	-	-	988	1228	1323
	H	deg	23	32	32	32	30
	K	mm	515	-	-	-	-
J	deg	58	88	88	88	83	
M	deg	58	92	92	92	97	
TPR Valve Setting	kPa	1400	1000	1000	1000	1000	
Weight	cartoned	kg	59	63	82	97	120

All models are suitable for either indoor or outdoor installation.

971, 9W1, 991, 992, series 160 to 400 models have left and right hand (dual handed - DH) water connections and a TPR valve fitting on the left hand side only.

Technical data is subject to change.

CONNECTIONS – PLUMBING

All plumbing work must be carried out by a qualified person and in accordance with the Standard AS/NZS 3500.4 and all local codes and regulatory authority requirements.

CONNECTION SIZES

- Hot water connection: Rp 3/4
- Cold water connection: Rp 3/4
- Relief valve connection: Rp 1/2

WATER INLET AND OUTLET

Each model water heater has dual handed cold and hot water connections. The water connections can be made to either side.

All pipe work must be cleared of foreign matter before connection and purged before attempting to operate the water heater. All olive compression fittings must use brass or copper olives. Use an approved thread sealant such as Teflon tape on all sealing threads.

An isolation valve and non-return valve must be installed on the cold water line to the water heater. An acceptable arrangement is shown in the diagram. Refer also to “Hot Water Delivery” on page 29 and to “Mains Water Supply” on page 28.

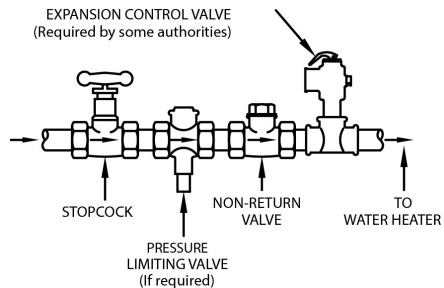

A disconnection union must always be provided at the cold water inlet and hot water outlet on the water heater to allow for disconnection of the water heater.

This water heater has either a plastic dip tube or fitting liner in the inlet and outlet fittings (see diagram). These must be in place for the water heater to function properly. Do not remove or damage them by using heat nearby. They will be pushed into the correct position as the fitting is screwed in.

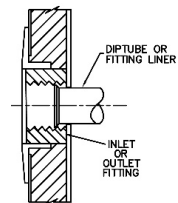

This water heater is intended to be permanently connected to the water mains and not connected by a hose-set. A braided flexible hose or semi-flexible connector may be used for connection to the water heater, where permitted by AS/NZS 3500.4.

LEFT AND RIGHT HAND SIDE WATER CONNECTIONS

The cold and hot water supplies can be connected to either side of a water heater with both left and right hand side connections.

A kit is supplied with the water heater to plug off the unused cold water and hot water fittings.

The kit contains:

Models 971160

- 2 x 3/4" brass plugs
- 2 x plastic caps
- 2 x insulation rubber discs, pre-fitted into plastic caps

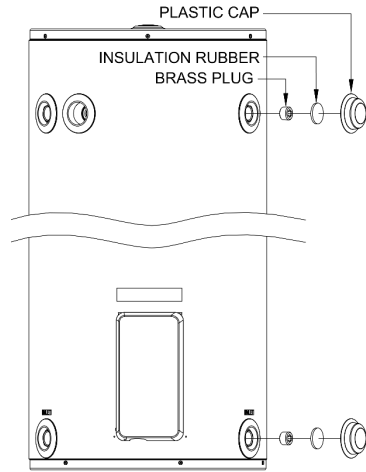

971160 model

Models 9W1160, 991 992 250 to 400

- 2 x 3/4" brass plugs

Plugging Off Unused Connections

- Apply approved sealing tape or compound to the thread of each plug.
- Fit the 3/4" plugs to the unused cold water and hot water fittings. Tighten the plugs using a 3/8" square driver.
- Fit a plastic cap (where supplied) with its insulation rubber disc over each plug.

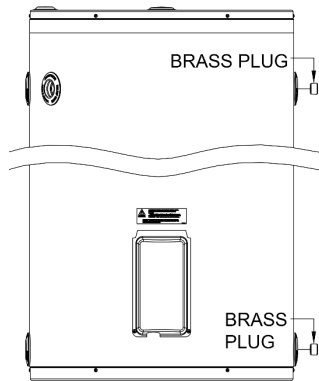

9W1160, 991 992 250 to 400 models

PIPE SIZES

To achieve true mains pressure operation, the cold water line to the water heater should be the same size or bigger than the hot water line from the water heater.

The pipe sizing for hot water supply systems should be carried out by persons competent to do so, choosing the most suitable pipe size for each individual application. Reference to the technical specifications of the water heater and local regulatory authority requirements must be made.

TEMPERATURE PRESSURE RELIEF VALVE

The water heater has a temperature pressure relief valve connection on its left hand side.

The temperature pressure relief valve is shipped in a plastic bag attached to the water heater. The temperature pressure relief valve must be fitted before the water heater is operated. Before fitting the relief valve, make sure the probe has not been bent.

To fit the relief valve:

- Seal the thread with an approved thread sealant such as Teflon tape - never hemp. Make sure tape does not hang over the end of the thread.
- Hand tighten the valve into the opening marked "Relief Valve" (refer to the installation diagram on page 33).
- Using a spanner engaged on the valve's spanner flats and applying medium pressure to tighten, turn the relief valve an additional $\frac{1}{2}$ to $1 \frac{1}{2}$ turns to secure and make the joint water tight, leaving the valve drain pointing downwards.

⚠ Warning: Do not use a pipe wrench or poor fitting tool on the valve body nor over tighten the valve, as this could damage the valve and prevent safe operation.

- Operate the easing lever on the valve to check the smooth operation of the valve plunger. It is very important the lever is raised and lowered gently. The lever should move smoothly and without undue force.

If the lever cannot be moved or is jerky in its movement, then the valve has been damaged and must be replaced.

- A copper drain line must be fitted to the temperature pressure relief valve (refer to "Relief Valve Drain" on page 38).
- The valve must be insulated with closed cell polymer insulation or similar (minimum thickness 9 mm) and the insulation installed so as not to impede the operation of the valve.

The insulation must be weatherproof and UV resistant if exposed.

The flexible insulation collar supplied with the temperature pressure relief valve meets these requirements and must be placed over the body of the valve (refer to the diagram on page 37).

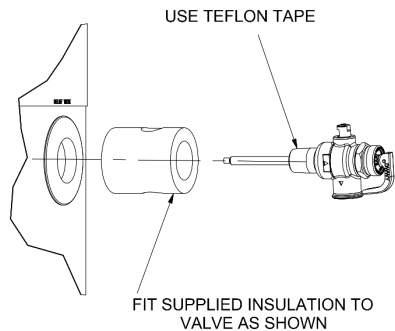

flexible insulation collar

EXPANSION CONTROL VALVE

Local regulations may make it mandatory to install an expansion control valve (ECV) in the cold water line to the water heater. In other areas, an ECV is required if the saturation index is greater than +0.4 (refer to “Water Supplies” on page 19).

The expansion control valve must always be installed after the non-return valve and be the last valve installed prior to the water heater (refer to diagram on page 35). A copper drain line must be fitted to the expansion control valve (refer to "Relief Valve Drain" on page 38).

The valve, if installed within 500 mm of the water heater, must be insulated with closed cell polymer insulation or similar (minimum thickness 9 mm) and the insulation installed so as not to impede the operation of the valve. The insulation must be weatherproof and UV resistant if exposed.

RELIEF VALVE DRAIN

DN15 copper drain lines must be fitted to the temperature pressure relief valve and expansion control valve (if one is installed) to carry the discharge clear of the water heater. Connect the drain lines to the valves using disconnection unions. The drain line from the valve to the point of discharge should be as short as possible, have a continuous fall all the way from the water heater to the discharge outlet and have no tap, valves or other restrictions in the pipe work. A drain line from a relief valve must comply with the requirements of AS/NZS 3500.4.

A drain line must be no longer than nine (9) metres with no more than three bends greater than 45° before discharging at an outlet or air break. The maximum length of nine (9) metres for a drain line is reduced by one (1) metre for each additional bend required of greater than 45°, up to a maximum of three additional bends. Where the distance to the point of final discharge exceeds this length, the drain line can discharge into a tundish.

Subject to local regulatory authority approval, the drain lines from the temperature pressure relief valve and expansion control valve from an individual water heater may be interconnected.

The outlet of a drain line must be in such a position that flow out of the pipe can be easily seen, but arranged so discharge will not cause injury, damage or nuisance. The termination point of a drain line must comply with the requirements of AS/NZS 3500.4. Drain lines must not discharge into a safe tray.

In locations where water pipes are prone to freezing, drain lines must be insulated, must not exceed 300 mm in length and are to discharge into a tundish through an air gap of between 75 mm and 150 mm.

If a drain line discharges into a tundish, the drain line from the tundish must be not less than DN20. The drain line from a tundish must meet the same requirements as for a drain line from a relief valve.

 **Warning:** As the function of the temperature pressure relief valve on this water heater is to discharge high temperature water under certain conditions, it is strongly recommended the pipe work downstream of the relief valve be capable of carrying water exceeding 93°C. Failure to observe this precaution may result in damage to pipe work and property.

CONNECTIONS – ELECTRICAL

The power supply to the water heater must not be switched on until the water heater is filled with water and a satisfactory megger reading is obtained.

All electrical work and permanent wiring must be carried out by a qualified person and in accordance with the edition of the Wiring Rules AS/NZS 3000 in force in the state or territory at the time of installation, and all local codes and regulatory authority requirements.

WATER HEATER

The water heater must be directly connected to a 220 V - 240 V a.c. 50 Hz mains power supply with an isolating switch installed at the switchboard.

The Wiring Rules AS/NZS 3000:2018 requires a second and lockable isolating switch be installed adjacent to but not on or attached to the water heater, and a residual current device (RCD) installed in the electrical circuit to the water heater. This isolating switch must isolate both circuits to a twin element water heater.

The second and lockable isolating switch and RCD may not be required if the installation of this water heater is considered a repair under Clause 1.9.3.2 of the Wiring Rules, i.e., the installation of the water heater is a straight change-over and with a straight disconnect / reconnect of the wiring and where there is no modification to the electrical wiring of the final subcircuit or no increase in electrical load above the circuit capacity.

The power supply to a twin element model should be Off-Peak (overnight) to the bottom heating unit and continuous to the top heating unit. The power supply to a single element model can be either an Off-Peak (overnight), Extended Off-Peak (overnight and day) or continuous electricity supply, depending upon the size of the water heater. Check with the local electricity supply authority as to their requirements. An Off-Peak (overnight) power supply will provide the maximum financial savings. Discuss the power supply requirements with the householder.

A flexible 20 mm conduit is required for the electrical cable to the water heater. The conduit is to be connected to the unit with a 20 mm terminator.

Connect the power supply wires directly to the terminal block and earth tab connection, ensuring there are no excess wire loops inside the front cover. The temperature rating of the power supply wires insulation must suit this application, or the wiring protected by insulating sleeving with an appropriate temperature rating if it can make contact with the internal storage cylinder. The temperature of the internal storage cylinder can reach 70°C under normal operation.

THERMOSTAT SETTING

The thermostat is adjustable from 60°C to 70°C. The factory setting of the thermostat is 70°C.

The thermostat is adjusted by turning the adjuster anticlockwise to decrease the temperature setting and clockwise to increase the temperature setting. Only adjust the thermostat setting when the isolating switch is switched off at the switchboard. The top thermostat on a twin element model is fixed at 60°C.

For reasons of safety and economy, we advise the thermostat be set at the lowest temperature that will provide sufficient hot water. Dishwasher running costs can be adversely affected if the thermostat is set below 65°C. Discuss the thermostat setting requirements with the householder.

**WIRING DIAGRAM TWIN ELEMENT ELECTRIC WATER HEATERS
NON-SIMULTANEOUS OPERATION, OFF-PEAK CONNECTION**

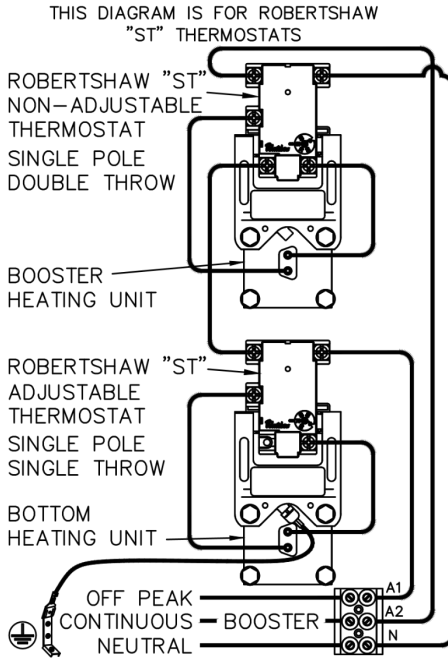

Top thermostat – fixed setting	60°C.
Bottom thermostat – tradesperson adjustable	min 60°C, max 70°C.

Electrical Circuit for Twin Element Models – Robertshaw “ST” Thermostats

The active from the continuous supply must be connected to the top heating unit circuit and the active from the Off-Peak or time controlled supply must be connected to the bottom heating unit circuit.

COMMISSIONING

TO FILL AND TURN ON THE WATER HEATER

The power supply to the water heater must not be switched on until the water heater is filled with water and a satisfactory megger reading is obtained.

- Open all of the hot water taps in the house (don't forget the shower).
- Open the cold water isolation valve fully on the cold water line to the water heater.

Air will be forced out of the taps.

- Close each tap as water flows freely from it.
- Check the pipe work for leaks.
- Inspect for leaks at the temperature pressure relief valve connection to the water heater.

If a leak is detected, close the cold water isolation valve fully and relieve pressure from the water heater by either operating the easing lever on the temperature pressure relief valve or opening a hot tap. Remove the valve and all of its thread sealant from the threads of the valve. Reapply new thread sealant and refit the valve. Refer to the procedure in "Temperature Pressure Relief Valve" on page 37.

- Operate the easing lever on the temperature pressure relief valve to check the smooth operation of the valve plunger and that water discharges freely from the drain line. It is very important the lever is raised and lowered gently. The lever should move smoothly and without undue force.

If the lever cannot be moved or is jerky in its movement, then the valve has been damaged and must be replaced.

- Switch on the electrical supply at the water heater isolating switch on the switchboard and at the isolating switch at the water heater (if installed).

Explain to the householder or a responsible officer the functions and operation of the water heater. Upon completion of the installation and commissioning of the water heater, leave this guide with the householder or a responsible officer.

TO TURN OFF THE WATER HEATER

If it is necessary to turn off the water heater on completion of the installation, such as on a building site or where the premises is vacant, then;

- Switch off the electrical supply at the water heater isolating switch on the switchboard and at the isolating switch at the water heater (if installed).
- Close the cold water isolation valve at the inlet to the water heater.

DRAINING THE WATER HEATER

 **Warning:** Exercise care, as water discharged from the water heater may be of a very high temperature.

To drain the water heater:

- Turn off the water heater (refer to “To Turn Off the Water Heater” on page 42).
- Close all hot water taps.
- Operate the relief valve lever - do not let the lever snap back or you will damage the valve seat. **It is very important the lever is raised and lowered gently.**

Operating the lever will release the pressure in the water heater.

- Undo the union at the cold water inlet to the water heater and attach a hose to the water heater side of the union.

Let the other end of the hose go to a drain.

- Open the relief valve by holding the lever in the raised position.

This will let air into the water heater and allow the water to drain through the hose.

INSTALLER INFORMATION

DEAR INSTALLER

Please provide the following information upon completion of the installation. This information should be provided to assist the customer in an event that a claim is to be made under the Aquamax warranty.

**Plumber
(Name & Company):**

**Plumber's
Licence Number:**

**Compliance Certificate
(if applicable):**

Installation Date:

Model & Serial Number:

**Water Heater
Date of Manufacture:**
