

Universal Cabinetry

Vanity Cabinets, Mirror Cabinets & Tallboys



CHECK GOODS THOROUGHLY BEFORE INSTALLATION

Installation of received goods that are damaged, warped or faulty will void warranty. Ensure all items meet your plumbing requirements.

Some movement may occur during transportation and installation that may cause doors and drawers to become unaligned. It is the responsibility of the installer to make any necessary adjustments after installation.



PLEASE LEAVE THIS GUIDE WITH THE OWNER

Before Installation

PLEASE READ THROUGH THIS INSTALLATION GUIDE CAREFULLY BEFORE INSTALLING THE PRODUCT.

Before installing, check that your wall is flat and plumb. If not, the cabinet will need to be packed out so that it sits level, otherwise the cabinet may twist, causing the doors and drawers to fall out of alignment and not function properly.

The cabinet should be installed over the top of a tiled wall with adequate clearance for doors and drawers to open. When installing the side of a cabinet against a wall, a fill panel can be used. See 'Installation Against a Wall' for more information. It is recommended that vanities are installed at least 300 mm away from wet areas such as showers and baths.

Cabinets with side panels, metal accent frames and undershelf panels MUST be fitted to the main body of the cabinet BEFORE mounting the cabinet to the wall. Please consult the separate instructions supplied with the product.

Mounting the Cabinet

Mount the cabinet using screws through the solid back panel of the cabinet. Screws should be selected to suit the stud material and have a pan or counter sunk head. Screws should be placed horizontally within 100 mm from the top of the cabinet, with a maximum of 300 mm of spacing horizontally. The screws near the left and right edge of the cabinet should be placed within 100 mm of each side.

When mounting vanity cabinets, use a spirit level to ensure that the cabinet is level and plumb on all sides. If not, remove the cabinet and adjust the wall or pack the back of the cabinet to correct the alignment. **DO NOT install the vanity top until the cabinet is level and plumb in all directions.**

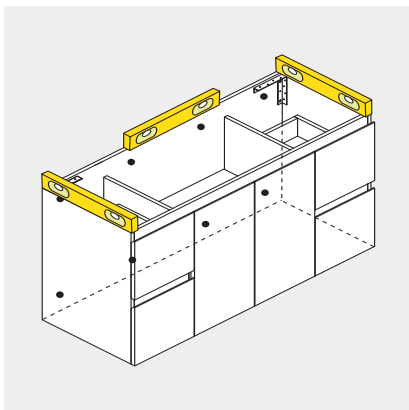

Vanities: Ensure cabinet is level and plumb. Mount to wall at the points detailed above.

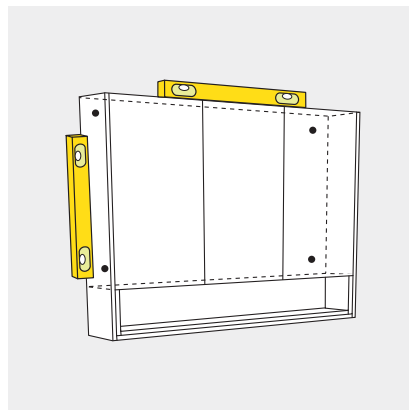

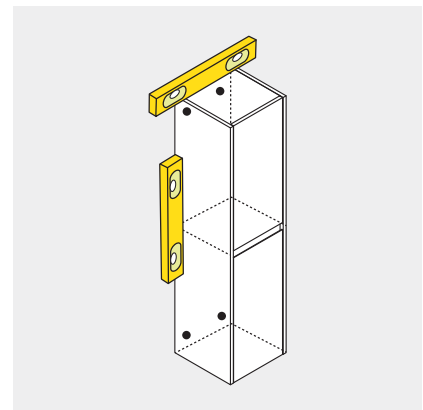

Mirror Cabinets: Ensure cabinet is level and plumb. Mount to wall studs with included screws in each corner.



Tallboys: Ensure cabinet is level and plumb. Mount with suitable screws in each corner.

All installations must be carried out by a licensed tradesperson in accordance with all applicable Building, Plumbing and Electrical codes, and Federal, State, or Local Government Regulations in accordance with AS/NZS 3500 Plumbing & Drainage, AS/NZS 6400:2016 Water Efficient Products, and AS/NZS 3000:2007 Electrical standards for any installations to which these standards apply.

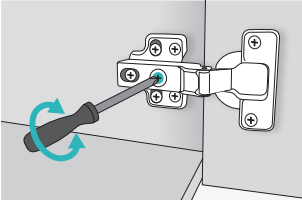
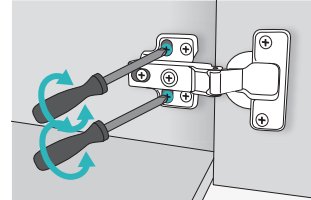
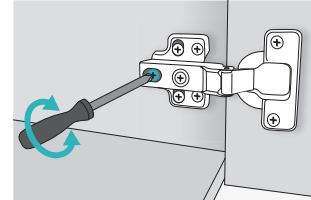
Adjusting the Doors

<p>Use the front screw to adjust door to the left or right.</p> 	<p>Loosen the two bracket screws to slide door up or down. Tighten screws.</p> 	<p>Use the back screw to adjust door further in or out.</p> 	<p>Some cabinets allow door to be removed (if required). Push the back of each hinge simultaneously.</p> 
---	--	--	--

Adjusting the Drawers

Lift the drawer up slightly for easy manual adjustment.

For AMATO, EDGE Scandi Oak, EDGE Industrial, FINGERPULL & HAMPTON Cabinets

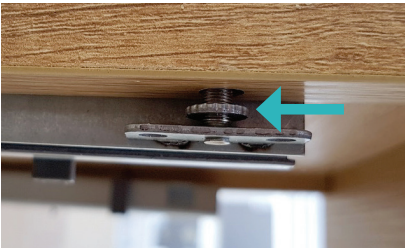
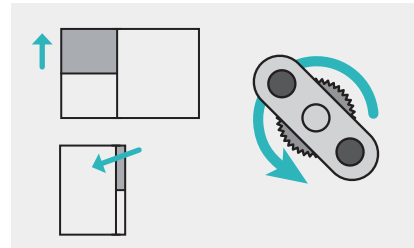
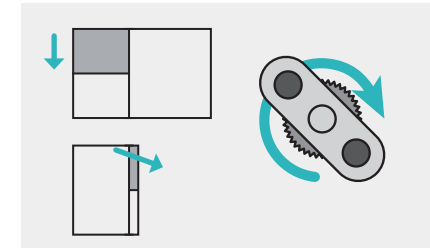
<p>Turn the nut on the underside of the drawer to make an adjustment.</p> 	<p>To move the drawer UP (backwards tilt) turn the nut anti-clockwise.</p> 	<p>To move the drawer DOWN (forward tilt) turn the nut clockwise.</p> 
---	--	---

For MANU (Main Drawer) & QUEST Cabinets

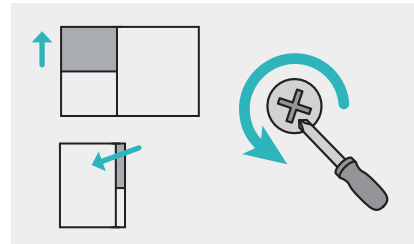
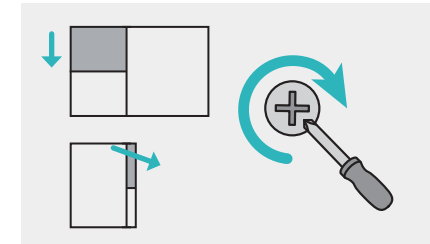
<p>Use a Phillips-head screwdriver to adjust the drawer via the screw circled below.</p> 	<p>To adjust the drawer UP (backwards tilt) turn the screw anti-clockwise.</p> 	<p>To adjust the drawer DOWN (forward tilt) turn the screw clockwise.</p> 
--	--	---

For ALINA Cabinets

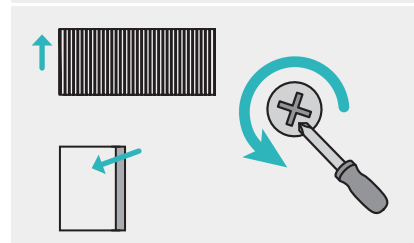
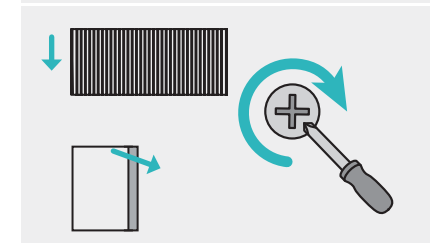
<p>Use a Phillips-head screwdriver to adjust the drawer via the screw circled below.</p> 	<p>To adjust the drawer UP (backwards tilt) turn the screw anti-clockwise on both sides of the drawer.</p> 	<p>To adjust the drawer DOWN (forward tilt) turn the screw clockwise on both sides of the drawer.</p> 
--	--	---

Removing the Drawers (If Required)

For AMATO, EDGE Scandi Oak, EDGE Industrial, FINGERPULL & HAMPTON Cabinets

Removal

1. Fully extend the drawer.
2. Locate the grey tabs underneath the drawer.
Pull out tabs until you hear a click.
3. Lift the drawer up and out.

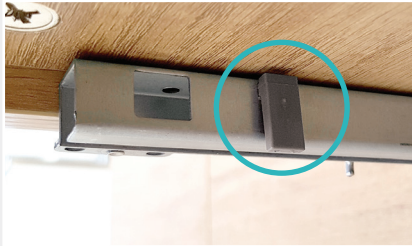

Re-Fitting

1. Ensure both drawer runners are fully extended.
2. Slide the drawer onto the top of the runner ensuring that the holes drop down onto the screws as shown.
3. Push grey tabs back in until you hear them click into place.

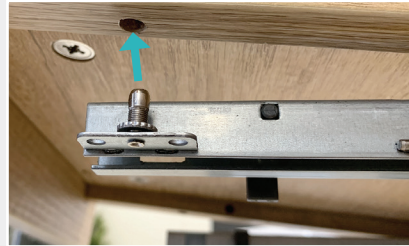

For MANU (Main Drawer) & QUEST Cabinets

Removal

1. Remove 'Fienza' cover tabs by popping them out with a flat head screwdriver.
NOTE: There are two tabs to remove for the 750 model, and four tabs for the 900 and 1200 models.
2. Use a Phillips-head screwdriver to unlock the cam lock located under the drawer.
3. Lift all release buttons upwards simultaneously.
4. Remove the drawer by sliding up and out.
NOTE: The 900 and 1200 models require two people to lift the drawer.



Re-Fitting

1. Refitting the drawer is easiest with two people. Ensure both drawer runners are fully extended.
2. Tighten the cam lock with a Phillips-head screwdriver.
3. Gently slide the drawer onto the runner until it clicks into place. All four runners may not click automatically into place. If this occurs, manually bring the runners forward until you hear them click into place.

All installations must be carried out by a licensed tradesperson in accordance with all applicable Building, Plumbing and Electrical codes, and Federal, State, or Local Government Regulations in accordance with AS/NZS 3500 Plumbing & Drainage, AS/NZS 6400:2016 Water Efficient Products, and AS/NZS 3000:2007 Electrical standards for any installations to which these standards apply.

For MANU (Internal Drawers), MILA & UNICAB Cabinets

Removal

1. To remove, extend the drawer fully.
2. Press UP on the left-hand side spring tab, while **simultaneously** pressing DOWN on the right one at the same time. This will release the drawer from the runners allowing you to slide the drawer out.

NOTE: Do not try to remove the drawer without pressing the spring tabs **simultaneously**, as this will cause damage to the runners.

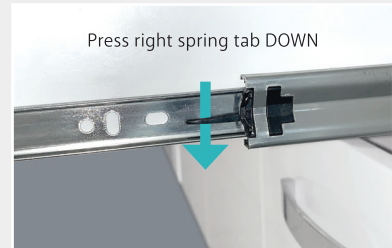

Re-Fitting

1. Ensure both drawer runners are fully extended.
2. Press UP on the left spring tab and DOWN on the right spring tab **simultaneously** as you gently slide the drawer back onto the runner.

For ALINA Cabinets

Removal

1. Remove the 4 x 'DTC' cover tabs by popping them out with a flat head screwdriver.
2. Use a Phillips-head screwdriver to unlock the cam lock located under the drawer.
3. Use a Phillips-head screwdriver to rotate the first screw (a.) anti-clockwise until it clicks into position (on both sides). Rotate the second screw (b.) anti-clockwise with the screwdriver and hold to release the drawer front (on both sides). Pull the drawer front away from the box drawer.
4. Press the locking device under the drawer (on both sides) and pull out the drawer.

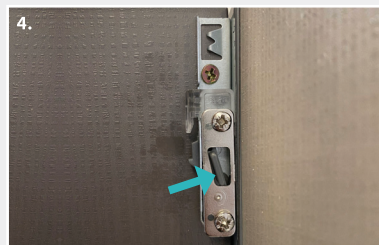
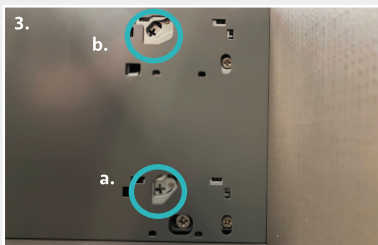

Re-Fitting

1. Push the drawer front back into place on the drawer and tighten the cam lock.
2. Tighten the cam lock with a Phillips-head screwdriver.
3. Ensure both drawer runners are fully extended.
4. Gently slide the drawer onto the runner until it locks into place. All four runners may not click automatically into place. If this occurs, manually bring the runners forwards until you hear them click into place.

Fitting the Top & Sealing the Cabinet

For vanities, fit the top to the cabinet by sealing all four edges with a neutral cure silicone.

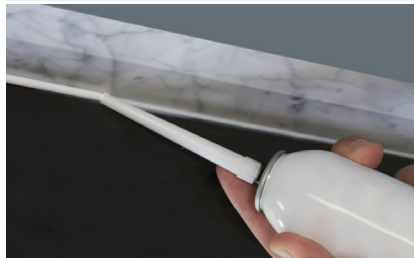

Seal all cabinet edges against the floor and wall to prevent water penetration.



When fitting the basin waste, tighten by hand only, and then use silicone to seal. Overtightening of the waste may cause undue stress and damage the basin or top.



Installation Against a Wall (Vanity Cabinets)

When installing the cabinet against a wall, a fill panel can be used to fill the gap between the wall and the side of the cabinet. For short cabinets, the panel must be cut to size to suit the height of the cabinet from floor to the bottom edge of the vanity top.

Standard Size: 50 W x 880 H x 18 D mm	
Finish	Item Code
Gloss White	F-BF18
Satin White	BF18MW
Scandi Oak	BF18S
Industrial	BF18X
Satin Black	BF18MB

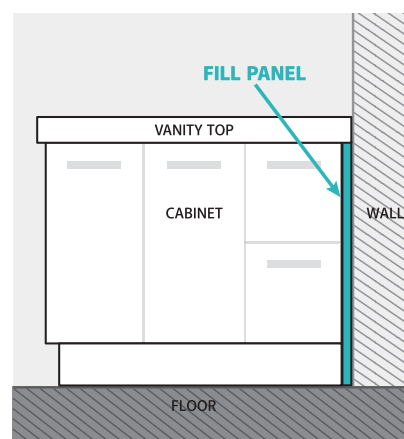

Cleaning & Care

The best method of maintaining the finish is simply to wipe over with a clean, soft cloth. It is important that no abrasive cleaners or wax-based creams are used as this can result in a build-up of deposits/scratches that will detract from the appearance.

Scratches

Avoid contact with hard, sharp objects. Should scratches occur on gloss lacquered cabinets, fine marks can be removed using a cutting compound normally used for car re-treatment, followed by buffing with a car polish and a clean, soft cloth.

Chemical damage

Spills of some products such as hair lacquer, after-shave lotion, nail polish and remover, mineral turpentine, white spirit, kerosene, aerosol propellants and insecticides should be removed immediately by cleaning the product with a soft cloth.

Burns

Avoid placing hot objects, such as hair straighteners, curling tongs or lit cigarettes on any surface as these will cause discolouration and marking. Should slight accidental damage occur, it may be possible to remove marks with the same approach as for scratches (refer to 'Scratches' above).

Discolouration

Hair dye, bleaches, boot polish and similar chemicals will discolour the surface if not removed immediately. Provided the discolouration is not severe, restore the surface as described for scratches.

All installations must be carried out by a licensed tradesperson in accordance with all applicable Building, Plumbing and Electrical codes, and Federal, State, or Local Government Regulations in accordance with AS/NZS 3500 Plumbing & Drainage, AS/NZS 6400:2016 Water Efficient Products, and AS/NZS 3000:2007 Electrical standards for any installations to which these standards apply.

Warranties

Residential Warranty Periods

Applies to domestic uses and applications of Fienza® products, such as private dwellings and retirement villages.

Commercial Warranty Periods

Applies to commercial uses and applications of Fienza® products, including, but not limited to: commercial food premises such as restaurants; commercial accommodation such as hotels; hospitals and healthcare facilities; public amenities; and industrial, laboratory and manufacturing facilities.

Product Component	Residential	Commercial
Cabinets (MDF only)	5 years replacement parts or product, 1 year labour	1 year replacement parts or product, 1 year labour
Handles, Hinges, Legs & Drawer Runners	5 years replacement parts	1 year replacement parts
Glass Doors & Mirror Doors	1 year replacement parts	1 year replacement parts

NOTE: Does not include door and drawer adjustment, or cabinets damaged by water leaks or burst hoses.

Australian Consumer Law

Our goods come with guarantees that cannot be excluded under the Australian Consumer Law. You are entitled to a replacement or refund for a major failure and compensation for any other reasonably foreseeable loss or damage. You are also entitled to have the goods repaired or replaced if the goods fail to be of acceptable quality and the failure does not amount to a major failure.

Fienza Pty Ltd reserves the right to make changes in product characteristics, packaging or availability at any time without notice. Please visit www.fienza.com.au for the latest information.

Warranty Conditions

- Installation has been carried out by a licensed tradesperson in accordance with all applicable Building, Plumbing and Electrical codes, and Federal, State, or Local Government Regulations in accordance with AS/NZS 3500 Plumbing & Drainage, AS/NZS 6400 Water Efficient Products, and AS/NZS 3000 Electrical standards for any installations to which these standards apply.
- All maintenance and adjustments to the product after the installation have been carried out by a licensed tradesperson.
- All care and cleaning instructions have been adhered to as prescribed.
- All goods of standard quality manufacture (excluding imperfections permitted within AS1976 - Vitreous China used in Sanitary Applications) will be credited or replaced by Fienza when advised within the warranty period, subject to prior inspection and agreement.
- Proof of purchase is required for warranty claims.

Warranty Limitations

To the extent permitted under the Trade Practices Act and other relevant legislation, Fienza's liability is limited to:

- The cost of replacing the goods, or
- The cost of obtaining equivalent goods, or
- The cost of having the goods repaired.
- Fienza is not responsible for any lack of operation or performance of goods (or any loss or damage) where goods are used or adapted for use with other goods not supplied by Fienza.
- It is the responsibility of the customer and installer before installation to ensure that all components are correct and free of obvious visible faults.
- Fienza is not responsible for the labour and rectification costs incurred in the above circumstance.

Conditions for On-Site Warranty Service Calls

Fienza will charge a service fee for each visit to an installation by its technician where it is determined that the fault is due to poorly executed or unlicensed installation work or where the product is not a genuine Fienza product or where the product is outside the warranty period. This may be paid in advance by credit card over the phone to a Fienza technician attending the site and will be refunded if the Fienza product is found to be at fault.

For warranty support, please contact Fienza

2 Bailey Court, Brendale QLD 4500 PO Box 5381, Brendale QLD 4500
P 07 3490 6700 **F** 07 3490 6719 **E** help@fienza.com.au ABN 76 136 411 311



All installations must be carried out by a licensed tradesperson in accordance with all applicable Building, Plumbing and Electrical codes, and Federal, State, or Local Government Regulations in accordance with AS/NZS 3500 Plumbing & Drainage, AS/NZS 6400:2016 Water Efficient Products, and AS/NZS 3000:2007 Electrical standards for any installations to which these standards apply.