

Components shown in Fig. 3 are supplied with the 300071W Urbane II Electronic Bidet Seat.

Before installation, make sure the water connection points and a Ø32mm conduit are in place to run the plug-in power cord connector through, as shown in Fig. 1 and Fig. 2.

Note: The Urbane II Electronic Bidet Seat is supplied with 1.5m plug-in power cord with an IP65 rated connector.

ROUGHING IN:

IMPORTANT: These operations must be performed by qualified service personnel.

Water Connection

- 1- Mark centre line of the pan on the floor and stud frame, install the G $\frac{1}{2}$ " (15mm projection from finished wall) connection in position as shown in Fig. 1.

Power Connection

- 1- Install a wall plate or similar item for the power cable in a location close to the GPO (not included) within 1m linear length from the pan centre line. If a longer cable is required, the cable connector can be removed and assembled with a longer cable, as shown in Fig. 2.

Waste Connection

- 1- The Urbane II Bidet Cleanflush® back inlet pan is universal for both 'S' and 'P'-Trap installations as detailed. The recommended set-out for 'S'-Trap installations is 90mm from the finished wall with set-out flexibility for existing soil pipe positions ranging from 60mm to 135mm and 50mm sideways adjustment with the Uni-Orbital® connector supplied, as shown in Fig. 4. Refer to installation instructions supplied with Uni-Orbital® connector.

Power Cable

- 1- Feed the power cable from the connector end through the wall plate and conduit, and pull the cable through the hole in the wall above the Uni-Orbital® connector, as detailed in Fig. 5. Wire draw fish tape can be used to pull the cable through.
- 2- Before proceeding ensure there is approx. 250mm of cable protruding from the wall.

INSTALLATION:

Water Inlet Connection:

- 1- Fit the stop valve onto the threaded elbow while keeping the G $\frac{1}{2}$ " end pointing upwards, as shown in Fig. 2. Apply thread tape on the stop valve thread.
- 2- Install the dual check valve onto the stop valve. Place the washer inside the female end of 'T' fitting then fit it on the spigot of the check valve while ensuring the horizontal threaded end is facing forwards. Apply thread tape on both threaded spigots of the 'T' fitting, as shown in Fig. 3.
- 3- Fit the G $\frac{1}{2}$ " end cap on the top spigot of 'T' fitting.
- 4- Screw the filter onto the front facing thread of 'T' fitting and hand tighten, as shown in Fig. 3.
- 5- Screw the G $\frac{1}{2}$ " connection end of bidet hose to the male thread of filter, hand tighten and tighten further using a spanner. **DO NOT OVERTIGHTEN AS IT MAY CRACK THE FILTER.** Connect the bidet hose to the inlet of bidet seat, turn the mains ON and check for leakage. Disconnect the bidet seat before proceeding.

'S'- TRAP CONNECTOR FIXING PROCEDURE

- 1- The centreline of the pan on wall and floor, as shown in Fig. 1 is to be used as a guide when connecting the pan. The centre line can be offset by up to 50mm from the soil pipe, as detailed in Fig. 4. **Note:** The water and power locations must be positioned relative to the pan centreline.
- 2- Determine set-out "A" of existing pan connector, as detailed in Fig. 4. Set-out range 60mm - 135mm. Recommended set-out 90mm, as detailed in Fig. 4 and Fig. 6. For 'P' trap installation, see Fig. 7.
- 3- For installation of the Uni-Orbital® connector, reference must be made to the instructions supplied with the connector.
- 4- Prepare for pan fixing method (bracket installation) as detailed below.

IMPORTANT: Feed flexible hose through the right hand side opening on pan before pushing pan onto Uni-Orbital® connector and wall, as detailed in Fig. 6 and Fig. 7.

Bracket Fixing:

- 1- Position and push pan into Uni-Orbital® connector and flushpipe using the marked centre line on the wall as a guide to ensure that all fittings locate correctly. Remove the pan.
- 2- Locate the D82 Concealed Fixing brackets (supplied) into position on centre line of pan 215mm from the finished wall and mark bracket fixing hole centres on finished floor.
- 3- Drill two holes in the marked positions on the floor. The hole diameter is dependent on the type of fixing system and floor finish.
- 4- Secure Brackets to finished floor.
- 5- Ensure that the area around the floor is clean and free from building material.
- 6- Run a bead of acetic cured silicone sealant at a height of 8mm approximately fully around the foot of the pan which contacts the floor, leaving a 5mm gap in an inconspicuous position to detect for leaks. Use Wedges around the foot base (if required) so that the **maximum height of silicone sealant is not greater than 5mm on completion.**
- 7- Ensuring the power cable is clear, carefully connect pan to connector and locate plastic fixing sleeve into holes in the pan. Fit screw into the bracket and tighten to bed pan to floor while ensuring level, as detailed in Fig. 9. **IMPORTANT: DO NOT OVER TIGHTEN, AS THIS MAY CRACK THE PAN FOOT.** Snap on plastic cap, as detailed in Fig. 9.
- 8- Provide support under the pan foot so that it is maintained in the levelled position while the silicone sealant sets. Remove any excess sealant to provide a neat joint between the pan and the floor. Allow at least 24 hours for the bedding sealant to set before use.

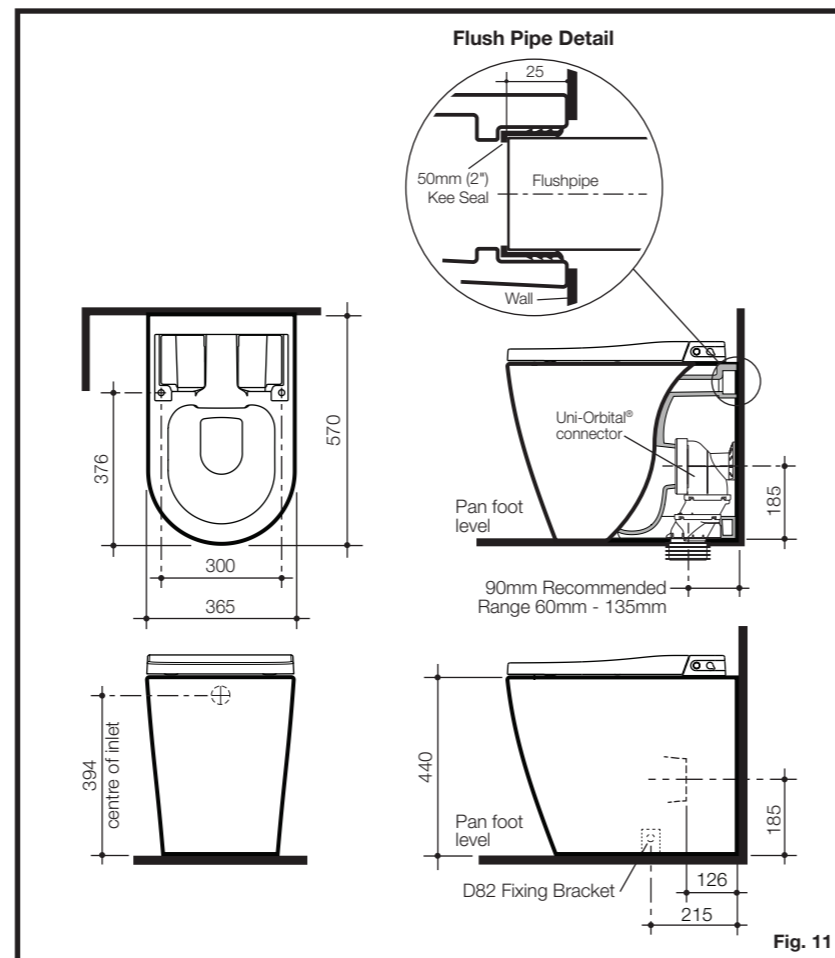
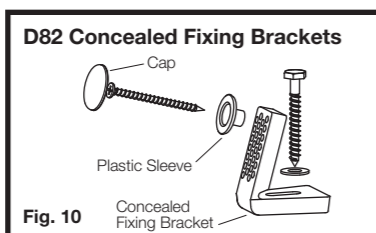
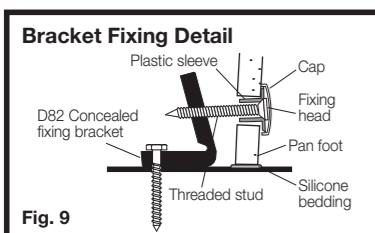
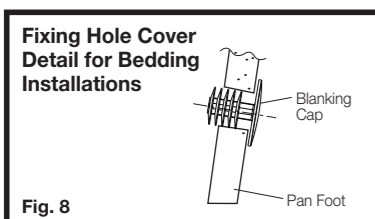
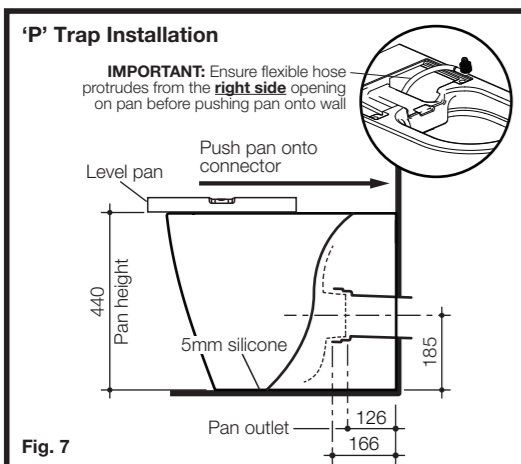
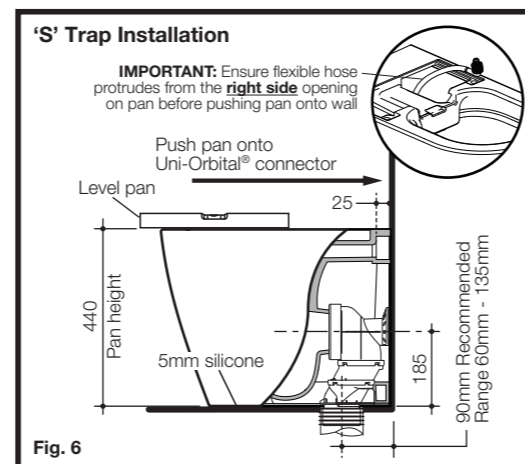
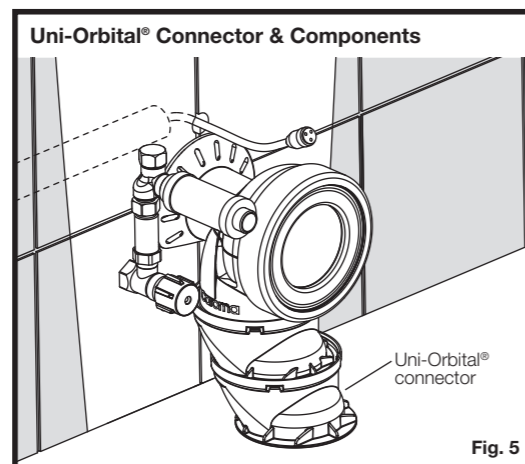
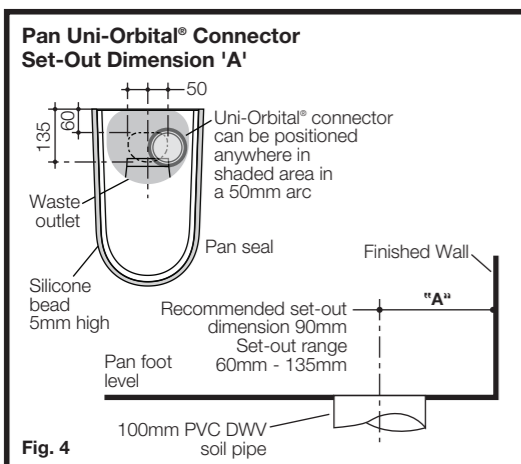

IMPORTANT
TO ACHIEVE A SATISFACTORY 4.5/3L FLUSH PERFORMANCE AND A 4 STAR WATER EFFICIENCY RATING THE CISTERN MUST BE MATCHED WITH A COMPATIBLE CAROMA SMARTFLUSH 4.5/3L TOILET PAN.

All measurements are subject to accepted manufacturing tolerances. To ensure accuracy please check actual product dimensions before drilling for installation. The manufacturer reserves the right to change specifications at any time without giving prior notification. This product should be installed by a qualified plumber. Local authority, Water Board, and Building Regulations may apply to the installation of this product, and you should consult the appropriate bodies on these requirements.