

Addison

WG White Gloss
ADD-BS-400-WG-S

WM White Matt
ADD-BS-400-WM-U



Inset

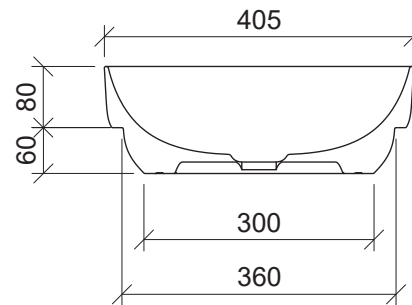
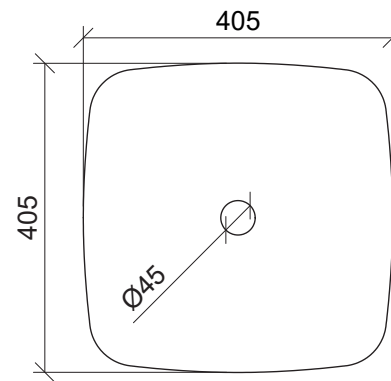

Drawings

Taphole Offset

Note: Offset or wall mounted tapware required.

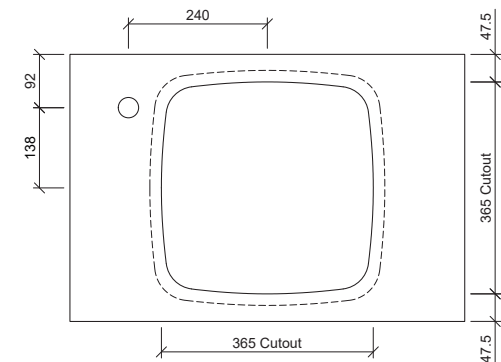

Cut Out Specifications

Material: Ceramic
Approx Capacity: 11L
Cut Out Size: 365w x 365d
Waste Size: 32mm without overflow

Note: Due to the manufacturing process, ceramic basins will vary from their nominal stated sizes. Use the dimensions provided as a guide only. Waste not included. Refer to brochure for pricing.