

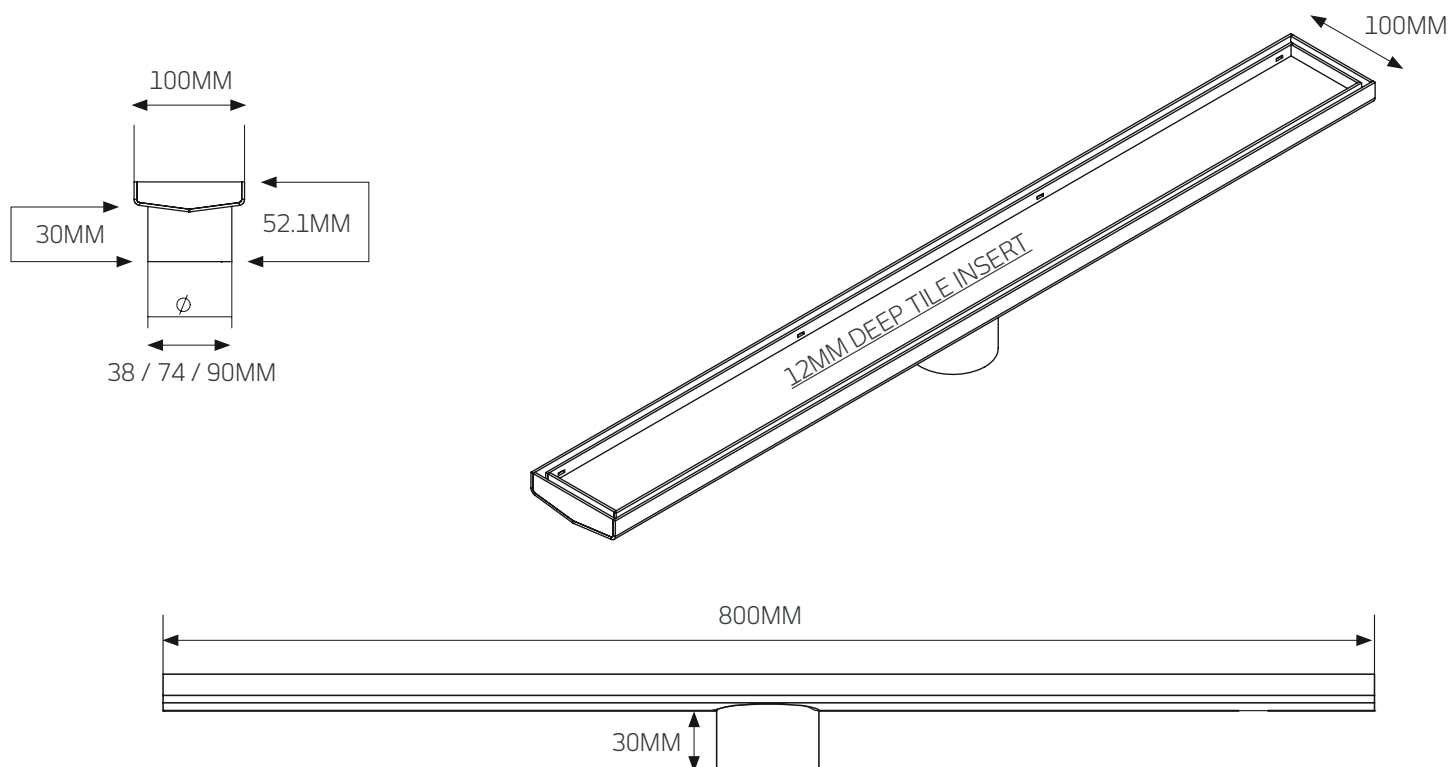







FLOOR GRATES

316-RGL-800 – 800 x 100 x 38/74/90mm



FEATURES	CODE	SIZE (MM)	COLOURS
• 316 Marine Grade Stainless Steel	316-RGL-800-38	800x100x38	Stainless Steel 
• Width: 100mm	316-RGL-800-74	800x100x74	Stainless Steel 
• Length: 800mm	316-RGL-800-90	800x100x90	Stainless Steel 
• Rolled edges to all exposed edges	316-BLK-RGL-800-74	800x100x74	Matt Black 
• Matt Black grates are Teflon Coated	316-GMG-RGL-800-74	800x100x74	Gun Metal Grey 
• All other colours are PVD coated	316-GLD-RGL-800-38	800x100x38	Brushed Gold 
• 12mm deep insert can accommodate up to 10mm tile + adhesive	316-GLD-RGL-800-74	800x100x74	Brushed Gold 
• With fixed central wastes	316-BN-RGL-800-74	800x100x74	Brushed Nickel 
• Covered by a 7 year warranty *			

Please note: Due to manufacturing constraints beyond our control, our coloured floor grates may have minor colour variances in different batches, so may be slightly different to the images and colour samples you may have seen.

* The replacement warranty for the coated grates are only applicable until the date of installation. Once Installed any damage to the coatings due to the incorrect use of cleaning products, mis-use or accidental damage, will not be covered under warranty.