

# Zen SS316L Hand Towel Ring

Nero

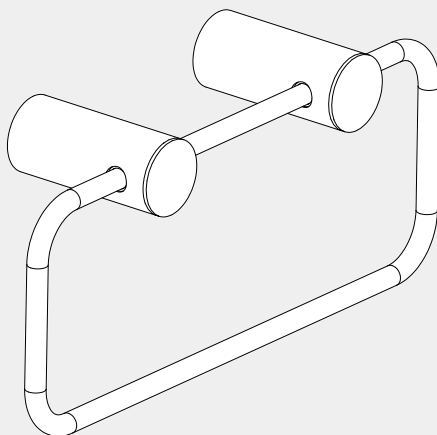

Versions:202405



## Drawing

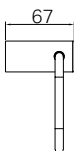
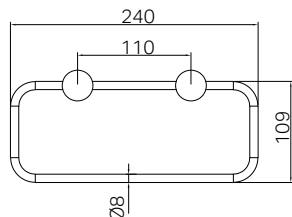

## Features

- 316L grade stainless steel construction for durability
- Easy to install

## Packaging Includes

1x Hand Towel Ring

## Finish & SKU

 **Brushed Bronze**  
NR1680BZ

 **Graphite**  
NR1680GR

 **Brushed Gold**  
NR1680BG

 **Brushed Nickel**  
NR1680BN

\*Dimensions are nominal measurements only.

# Installation Instruction

## GENERAL PRECAUTIONS AND WARNINGS

- Before installation, make sure the wall surface is clean and dry to ensure a secure attachment.
- When tightening screws, do not apply excessive force to prevent damage to the wall or the fixtures.
- Use the correct tools: a drill with a 6mm bit, screwdriver, and level.
- Wear appropriate safety gear, such as gloves and safety glasses, to protect yourself during installation.
- Before drilling, check the wall for any hidden pipes or electrical wires to avoid accidental damage.
- Ensure all measurements are accurate before drilling holes to prevent misalignment of the accessories.

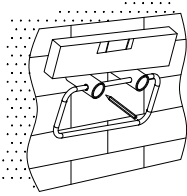

1. Place the towel ring in the desired installation position. Use a level to ensure it is horizontal. Mark the positions directly below the bases with a marking pen.

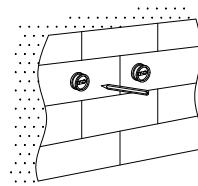

2. Position the fixing blocks at the marked spots. Mark the drilling points through the fixing block holes.

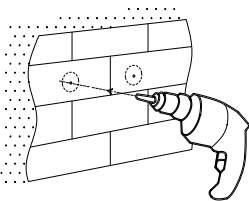

3. Use an electric drill with a 6mm drill bit to drill holes at the marked points.

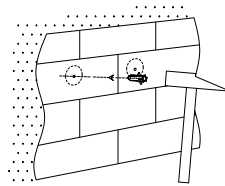

4. Insert the expansion plugs into the drilled holes using a hammer.

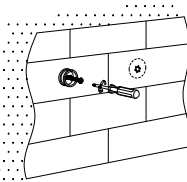

5. Place the fixing block covers over the holes and secure them firmly with expansion screws.

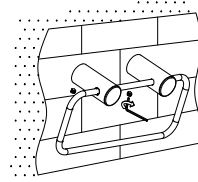

6. Install the towel ring onto the fixing blocks. Tighten the grub screws into the base to secure it tightly and firmly against the fixing.