

Zen SS316L Freestanding Bath Mixer

Nero

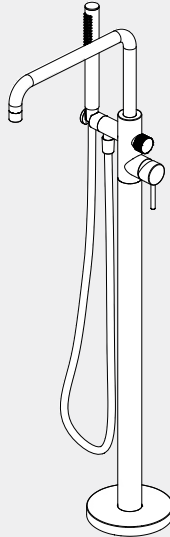

Versions:202405



Drawing

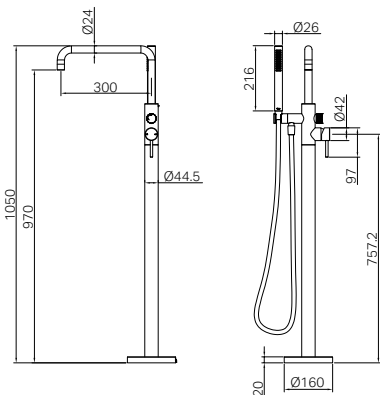

Specifications

Watermark License

WM-060073

Temperature Rating

Min 1°C-Max 75°C

Pressure Rating

Min 150kpa - Max 500kpa

Finish & SKU

With Outdoor Shower Hose

- Brushed Bronze
NR162203a01BZ
- Brushed Gold
NR162203a01BG

- Graphite
NR162203a01GR
- Brushed Nickel
NR162203a01BN

With PVC Shower Hose

- Brushed Bronze
NR162203a02BZ
- Brushed Gold
NR162203a02BG

- Graphite
NR162203a02GR
- Brushed Nickel
NR162203a02BN

Packaging Includes

- 1x Mixer Tap
- 1x Straight Pipe
- 1x Decorative Cover
- 2x Water Pipes
- 1x Mixer Box
- 1x Hand Shower(built-in Check Valve)
- 1x Shower Hose
- 2x Gloves
- 1x Allen Key Set

*Dimensions are nominal measurements only.

Installation Instruction

GENERAL INSTRUCTIONS:

- This product must be installed by a licensed plumber. Ensure that your plumbing installation conforms to the Australian/New Zealand Standard AS/NZS 3500.
- All pipework must be thoroughly flushed prior to the installation of the mixer. In-line filters must be fitted on both hot and cold supplies to prevent foreign particles from damaging the ceramic cartridge.
- All outlets used primarily for personal hygiene must deliver water at a safe temperature in accordance with regional regulations.

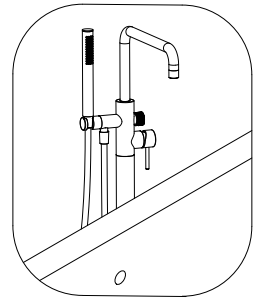
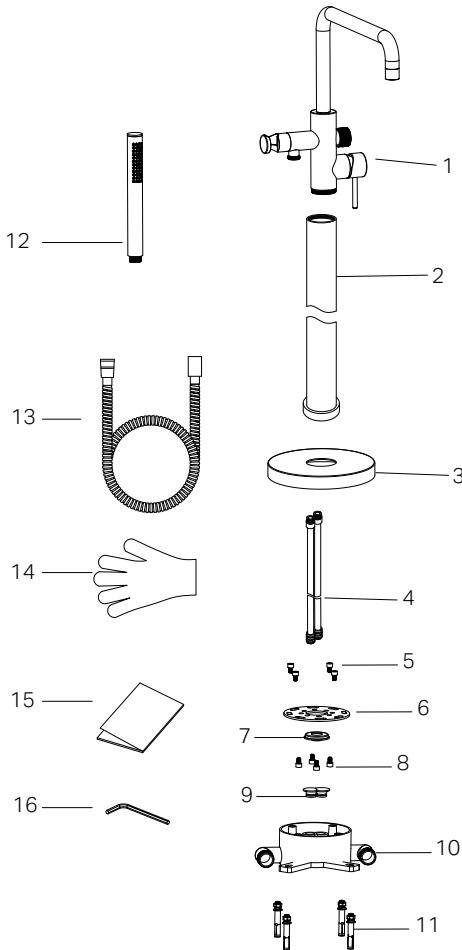

Parts

1. Main Body
2. Straight Pipe
3. Decorative Cover
4. Inlet Pipe
5. Straight Pipe Screws
6. Leveling Plate
7. Spirit Level
8. Flange Screws
9. Testing Plugs
10. Concealed Box
11. Expansion Screw Set
12. Hand Shower
13. Shower Hose
14. Gloves
15. Manual
16. Allen Key Set

NOTE:

To install the mixer, the floor thickness must be at least 50mm. If it is insufficient, the floor should be raised by at least 30mm before installation.

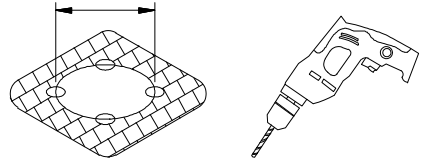
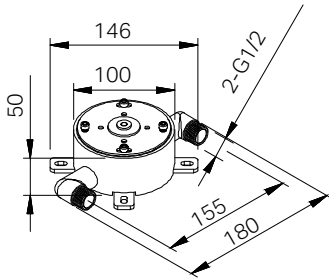

1. Mark the points according to the dimensions.

2. Drill holes in the floor out the marked points, ensuring the distance from the bathtub to the concealed box is correct. Mark the points according to the dimensions.

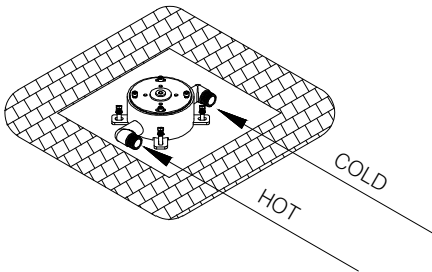

3. Adjust the concealed box to the correct position by spirit level and secure it with M6 expansion screws.

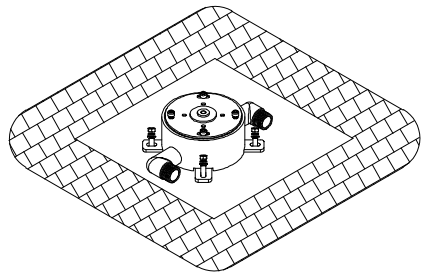

4. Connect the inlet pipes according to the hot and cold water indicators. Conduct a water pressure test to ensure there are no leaks.

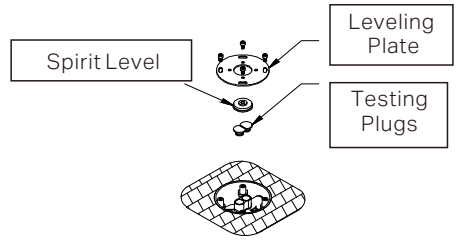
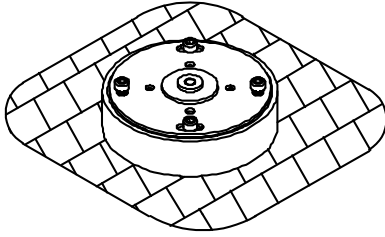

5. Protect the concealed box while filling the floor around it.

6. Remove the screws and leveling plate, take out the spirit level and test plugs.

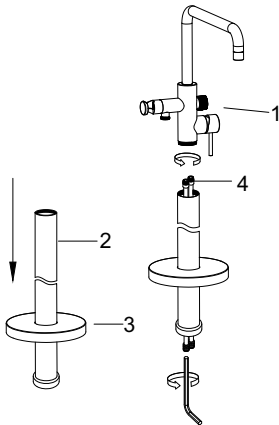

7. Slide the decorative cover onto the straight pipe from the top. Then connect the inlet pipe to the main body using an H8 Allen key, ensure the hot and cold water pipes are not swapped.

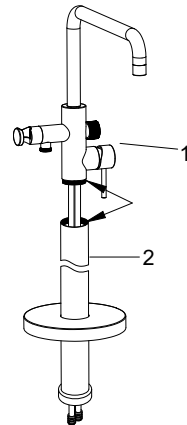

8. Connect and secure the main body to the straight pipe.

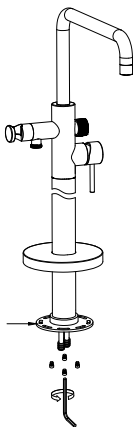

9. Use an H3 Allen Key to tighten the screws through the straight pipe, connecting the fixed pipe and the straight pipe.

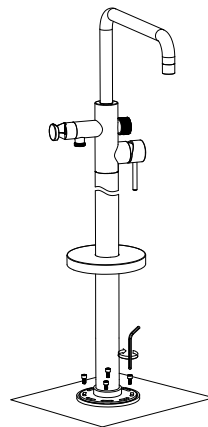

10. Insert the inlet pipe into the corresponding hole of the concealed box, adjust the position of the spout outlet and the bathtub, and secure them with the concealed box.

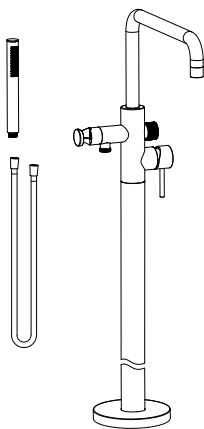

11. Connect hand shower with the hose and the main body.

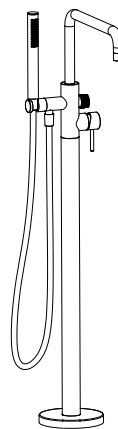

12. Ensure all parts are securely attached and aligned properly.

MAINTENANCE AND CARE:

- Regularly check the mixer and connections for signs of wear or leaks.
- Clean the tap with mild soapy water to maintain its appearance, avoiding harsh chemicals and abrasive materials that may damage the finish.

FINAL INSPECTION:

- Ensure the tap operates smoothly and that there are no leaks at the connections.
- Clean the area and the newly installed tap with a soft cloth to remove any installation residues.

Nero

