

90 Degree Glass To Wall Shower Hinge 10mm Glass

Nero

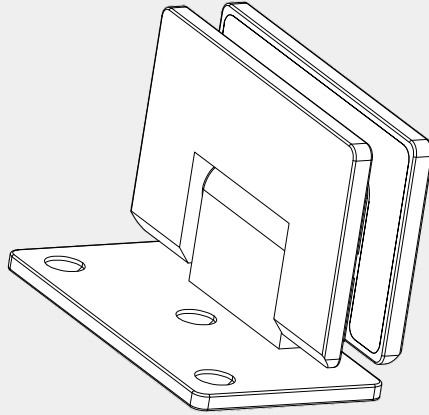

Versions:202401



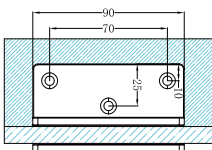
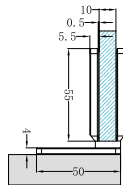
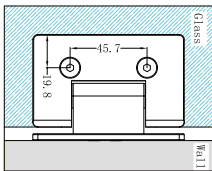



Drawing



Specifications

1. Glass to wall hinge.
2. 90 degree glass to wall connection.
3. Single side mount plate with 3 wall fixing holes.
4. Suitable for 10mm glass.
5. 35kg max door weight per two hinges.
6. 52.5kg max door weight per three hinges.
7. 800mm maximum door width.
8. Hex head machine screws.
9. Supplied with 50mm wall fix screws.
10. Hinges can open in & out 90 degree.
11. Self closing from approximately 30 degree.
12. Manufactured from high quality brass.

Finish & SKU

- | | | |
|---|--|--|
|  Chrome
NRSH101aCH |  Gun Metal
NRSH101aGM |  Brushed Bronze
NRSH101aBZ |
|  Matte Black
NRSH101aMB |  Brushed Gold
NRSH101aBG |  Brushed Nickel
NRSH101aBN |

*Dimensions are nominal measurements only.

INSTALLATION STEPS

Step 1: Cut out of the glass hole as below shadow part.

Step 2: Use allen key loosen the screw.

Step 3: Put the hinge insert into cut out of glass hole, then lock the screw.

Step 4: Put the plastic plug insert to wall, after put M5 screw use phillips screwdriver tighten screw.

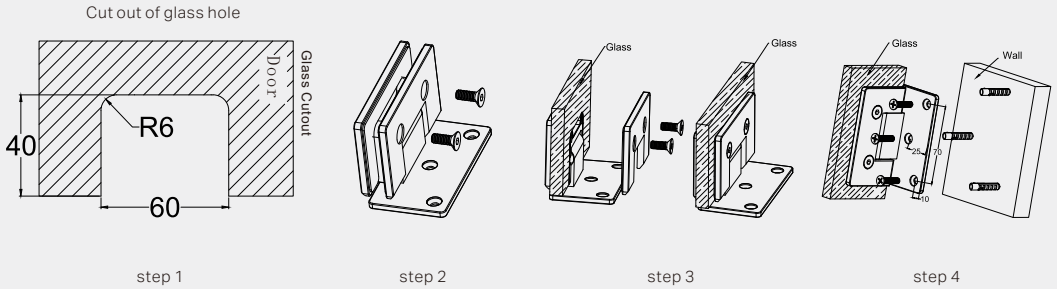

MAINTENANCE AND CARE

All surfaces should be cleaned with mild liquid detergent or soap and water.

Do not use cream cleaners or citrus based cleaning products, as they are abrasive.

Use of unsuitable cleaning agents may damage the surface.

Any damage caused in this way will not be covered by warranty

NOTE:

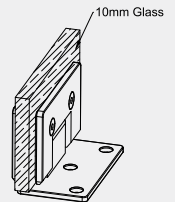

Only use for 10mm glass

Nero