

Square Shower Knob Handle

Nero

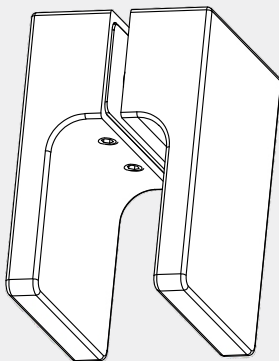

Versions:202401



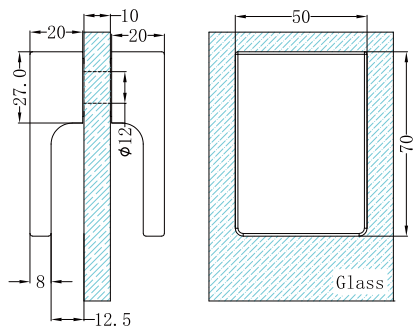



Drawing



Specifications

1. Suitable for 10mm glass.
2. Manufactured from high quality brass.

Finish & SKU

 Chrome NRSH302aCH	 Gun Metal NRSH302aGM	 Brushed Bronze NRSH302aBZ
 Matte Black NRSH302aMB	 Brushed Gold NRSH302aBG	 Brushed Nickel NRSH302aBN

*Dimensions are nominal measurements only.

INSTALLATION STEPS

Step 1: Cut out of the glass hole as below shadow part.

Step 2: Use allen key loosen the screw, take out the rubber padded and phillips screws and brass sleeves.

Step 3: Put B part into cut out of glass hole firstly, then put rubber padded and brass sleeves on it.

Step 4: Finally put A part onto it and lock the screws.

Cut out of glass hole

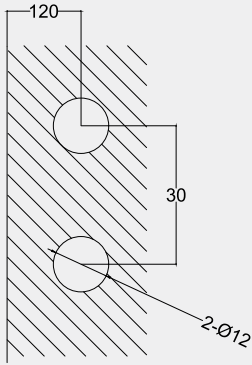

step 1

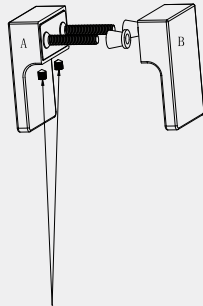

step 2

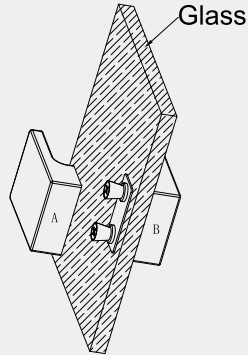

step 3

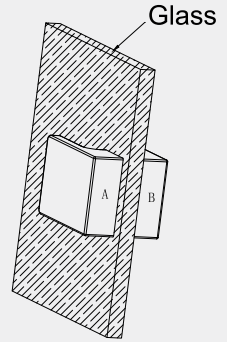

step 4

MAINTENANCE AND CARE

All surfaces should be cleaned with mild liquid detergent or soap and water.

Do not use cream cleaners or citrus based cleaning products, as they are abrasive.

Use of unsuitable cleaning agents may damage the surface.

Any damage caused in this way will not be covered by warranty.

NOTE:

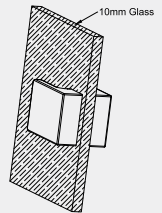

Only use for 10mm glass

Nero

info@nerotapware.com.au
nerotapware.com.au
www.nerotapware.com.au

11-13 Buontempo Road
Carrum Downs Vic 3201

10 YEARS WARRANTY
10
10 YEARS WARRANTY