

MOUNTING KIT

- 1: Dress Plate
- 2: Mounting Plate
- 3: Grub Screw
- 4: Allen Key
- 5: Self Tapping Screw x 8
- 6: Screw with Spring Toggle x 8
- 7: Plastic Plug 30mm x 8
- 8: Screw x 4
- 9: Metal Washer x 4
- 10: Mounting Tube x 4

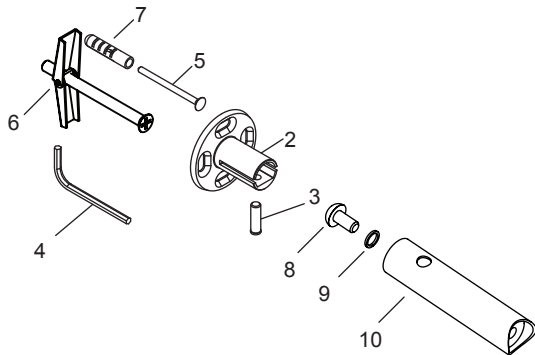
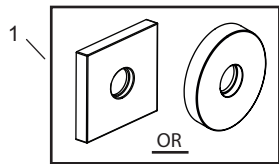

1

Fasten Mounting Tube onto Towel Ladder with screw.

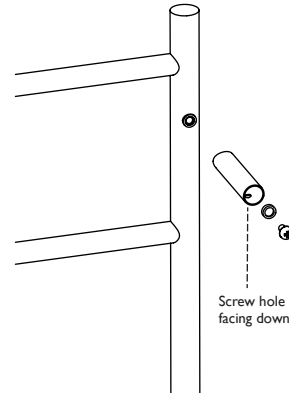

2

Insert Mounting Plates into the top mounting tubes. Position Towel Ladder in preferred location.

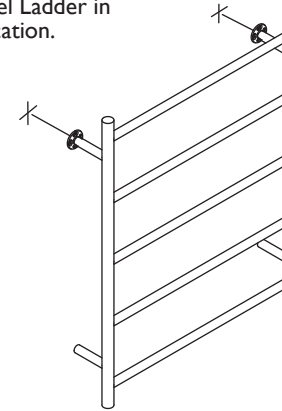

3

Ensure the towel Ladder is level, then mark the positions of the left and right hole on the mounting plate.

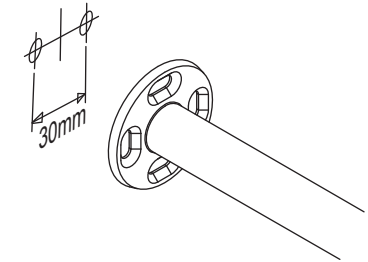

4

For fixing to brick walls with hard plaster or ceramic tiled surface:

Using a 6mm masonry drill bit, drill 2 holes 30mm deep. Press plugs into holes. Guide Self Tapping Screws through the Mounting Plate, into the plastic plugs and tighten with screwdriver.

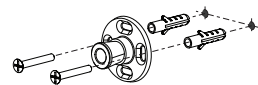

For fitting to stud walls clad with wallboard, with or without ceramic tiles:

Using a 10mm drill bit, drill through to wall cavity. Remove Screws from Spring Toggles. Guide Screws through the Mounting Plate, screw on the Spring Toggles and push them into the holes. Tighten with screwdriver.

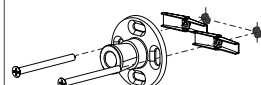

5

Push Mounting Plates into lower Mounting Arms. Fit Towel Ladder onto top Mounting Plates. Mark hole positions for the lower Mounting Plates. **REPEAT STEP 4**

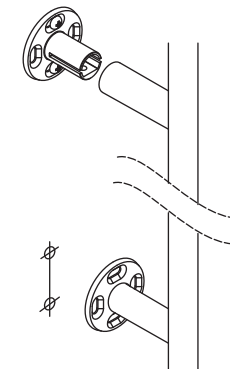

6

Place Dress Plates over Mounting Plates. Push Towel Ladder onto Mounting Plates. Ensure the Mounting Tubes are pushed up against the step of the Dress Plate. Insert Grub Screws into holes in each mount tubes. Tighten with Allen Key provided.

NOTE

Ensure the Square Dress Plates remain straight as the grub screw is tightened.

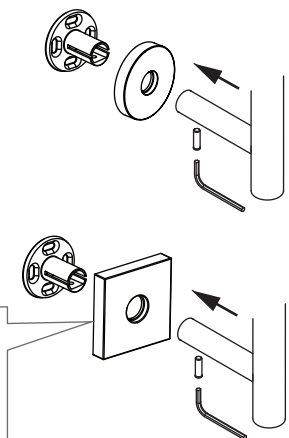

WARRANTY:

Please refer to the full warranty statement enclosed with the product before installing. Or visit www.phoenixtapware.com.au to download a copy.

MAINTENANCE AND CARE:

- Products should be cleaned with mild liquid detergent or soap and water.
- Do not use cream cleaners or citrus based cleaning products, as they are abrasive.
- Use of unsuitable cleaning agents may damage the surface. Any damage caused in this way will not be covered by warranty.

DISCLAIMER:

While we aim to ensure the specifications shown are correct at the time of printing, Phoenix Tapware reserves the right to make modifications without prior notice. Always use the physical product measurements for mark-ups and roughing-in as the line drawing shown may differ from the actual product over time.

*All measurements are shown in millimeters.