



EPIC ACCESSORIES - 600mm SINGLE TOWEL RAIL

INSTALLATION INSTRUCTIONS

Important Information:

- * **Hollow wall anchor (1) is only suitable for use in cavity walls with a tiled surface. If installing into a plasterboard cavity wall (untiled) it is recommended that the accessory be attached to the wall in line with a stud or noggin using suitable screws.**
- * **To prevent drill from wandering on tiled surfaces it is recommended that masking tape be applied before drilling.**
- * **Centre distance between drilled holes:- 600 ±1mm.**

Installation

- 1) Determine a suitable position for the towel rail on the wall. Accurately mark the hole positions on the wall, ensuring they are horizontally aligned and at the correct centre distance from each other.
- 2) **SOLID WALLS:-**(Brick, masonry blocks, concrete etc)
 - i) Drill holes 6.00mm diameter, 40mm deep.
 - ii) Insert rounded end of wall plugs (2) into drilled holes and tap until flush with the wall surface.
 - iii) Fit screw (4) through the hole in each mounting bracket (3), and insert into wall plugs (2). Position the mounting brackets (3) so that they are in correct alignment and the flat is at the bottom then tighten screws (4).

TILED CAVITY WALLS:-(Plasterboard/tile, fibre cement sheet/tile)
Note: Total wall thickness must be between 8-13mm.

- i) Drill holes 8.00mm diameter.
- ii) Flatten barbs on head flange of wall anchors (1). Insert the wall anchors (1) into the drilled holes until the head flange is against the wall surface.
- iii) Fit the wall anchor M4 screws (5) with washers (6) through the hole in each mounting bracket (3) before screwing them into installed wall anchors. Position the mounting brackets (3) so that they are in correct alignment and the flat is at the bottom then tighten screws (5).

UNTILED CAVITY WALLS:-(Plasterboard)

- i) Drill holes to suit fixing screws chosen for attachment to stud or noggin in the wall.
- ii) Fit suitable screws through the hole in each mounting bracket (3) and screw directly into stud or noggin.
- iii) Position the mounting brackets (3) so that they are in correct alignment and the flat is at the bottom then tighten screws.

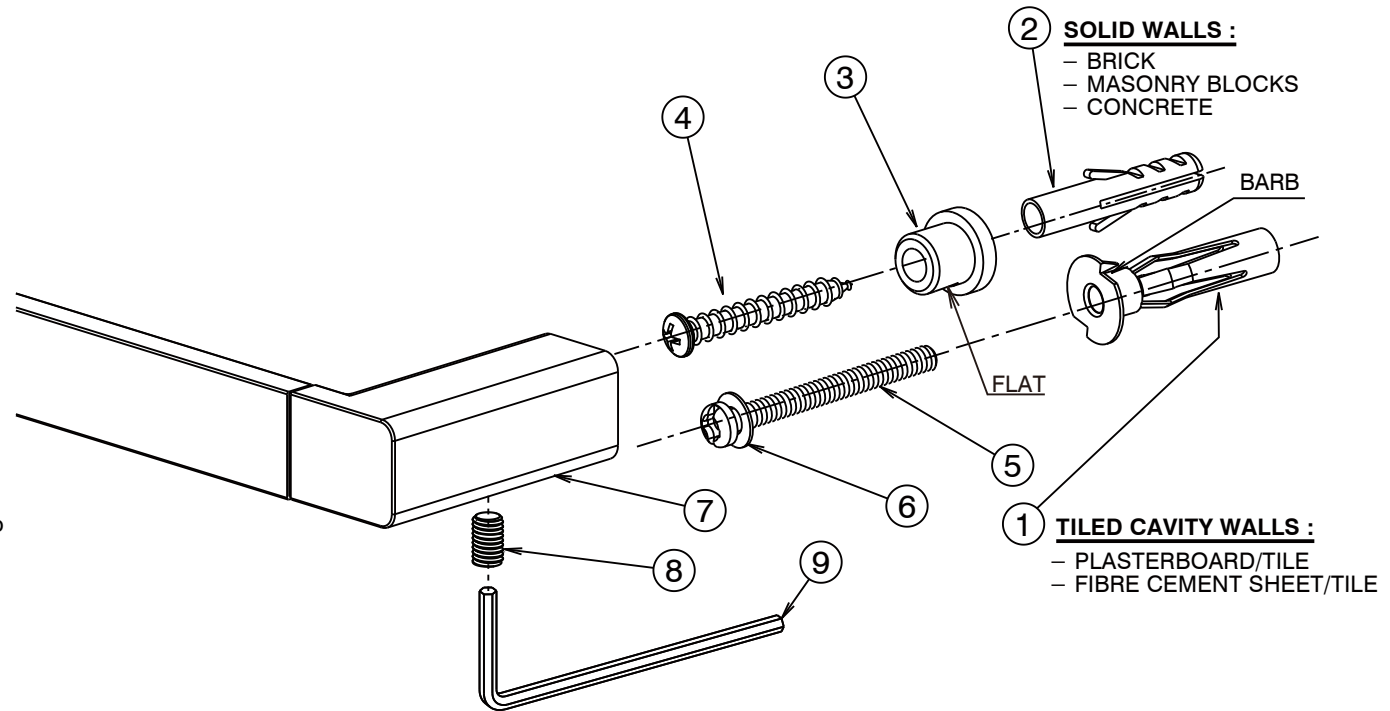

Fig.1

- 3) Install the towel rail (7) onto the mounting brackets (3). Push the towel rail against the wall surface while tightening the grub screws (8) using the 2.5mm allen key (9) provided. Ensure that the grub screws (8) engage with the flats on the mounting brackets (3) before tightening.