

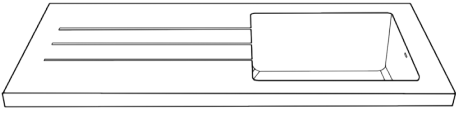







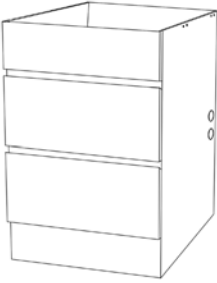

# Bloom Laundry Unit Installation Guide

Page 1 of 2

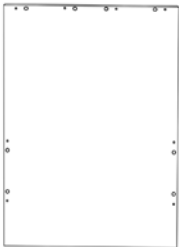
Contents					
Polymarble Top	x 1		Bloom Back Brace	x 1	
			Bloom Top Brace	x 1	
Bloom Assembled Drawer Cabinet	x 1		Timber Dowels	x 8	
			Cam lock Screws	x 8	
			Cam Locks	x 8	
			Blanking Stickers	x 14	
Bloom Return End	x 1		Plastic Caps	x 2	
			Plastic Grommets	x 2	
			90mm Basket Waste	x 1	
Tools Required – Phillips Head Screwdriver					
For best results, we recommend that two people assemble this product.					

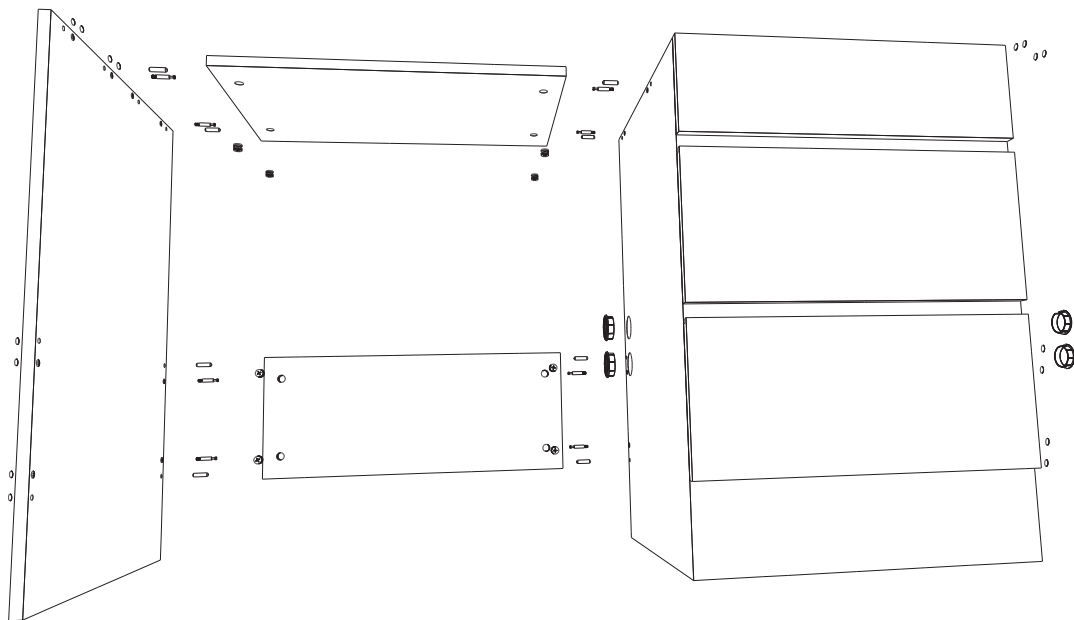

## Step 1- Preparing the assembly

While facing the assembled Drawer Cabinet, determine where the washing machine will be positioned. On that side, insert the Timber Dowels into the suitable holes located along the top and back edge of the side of the Drawer Cabinet (4 Dowels in total). Insert the Cam Lock Screws into the threaded holes next to the location of the Dowels. Screw in the Cam Lock Screws in by hand, do not over tighten.

Repeat this process on the Return End.

Insert Cam Locks into the holes on both the Top Brace and Back Brace of the cabinet.

# Bloom Laundry Unit Installation Guide

Page 2 of 2

## Step 2 - Assembling the Cabinet

Attach both the Top Brace and Back Brace to the Return End by aligning the Timber Dowels and Cam Lock Screws located on the Return End into the holes and Cam Locks located on the Braces. Once the Timber Dowels and Cam Lock Screws are inserted into both the Back Brace and Top Brace, using a Phillips Head Screwdriver turn the Cam Lock clockwise to lock the Cam Lock Screws into place.

Repeat this process to attach the Back Brace and Top Brace to the Drawer Cabinet.

## Step 3 - Putting the unit in place

Place the Assembled Cabinet into position in the room. As there is a void behind the drawers, there is room for taps. If needed, additional holes can be drilled into the Cabinet's Return using a 49mm hole saw.

## Step 4 - Addressing the holes in the Cabinet

Insert the Plastic Grommets into the holes facing towards the washing machine space. The Plastic Caps can be used to blank off the holes that are on the outside of the Drawer Cabinet. The Blanking Stickers can be used to cover the unused Dowel and Screw holes.

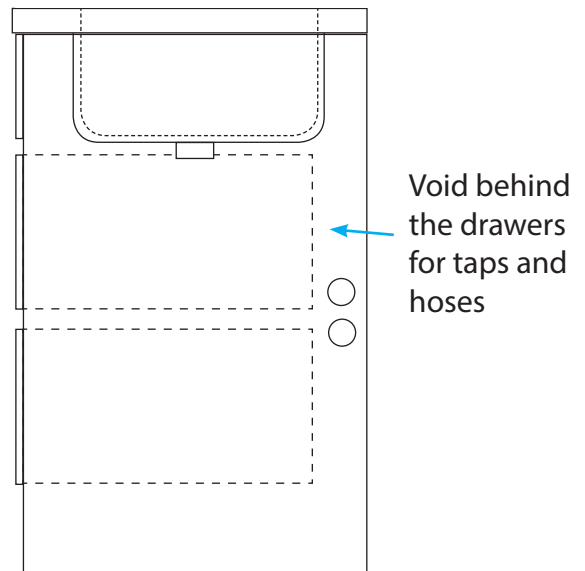

Side View

## Step 5 - Placing the Polymarble Top

Place a bead of silicon on the top edges of the Cabinet and on the surface of the Polymarble Top that will be against the wall. Place the Polymarble Top onto the Cabinet and wipe off excess silicon.

## Step 6 - Installing the front loader washing machine

Slide the washing machine into the void using the holes in the Cabinet to attach the washing machine inlet hoses to the taps and the electrical cord to the outlet. Install the mixer tap (if applicable).

## Step 7 - Install the waste

Install the two part basket waste and seal it using an appropriate silicon sealant. Connect a 50mm S&P trap (not supplied.) We recommend using a 50mm Overflow Trap Extension (Product code 97945, not supplied) for connection to the washing machine rinse hose.

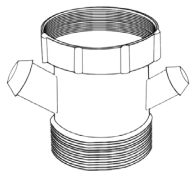

## Step 8 - Connecting the washing machine rinse hose

The washing machine rinse hose can be fed through the hole on the side of the Drawer Cabinet and connected to the 25mm connection on the overflow junction and attached using a stainless steel hose clamp.

