



Alor Sink Mixer 160mm Squareline

Product Code:133230

1800 RAYMOR
raymor.com.au

Raymor
more like you

Alor Sink Mixer 160mm Squareline

PRODUCT SPECIFICATION

Product Code	133230
Material	Brass Body
Handle	Zinc Die Cast Handle
Finish	Chrome Plated
Cartridge	35mm
Handle Style	Tapered Paddle
Installation depth	N/A
Hot/Cold Indicator	Laser etched H and C on handle
Warranty	Visit www.raymor.com.au
WELS-Rating	WELS 4 STAR 7.0L/min
Spout Reach	160mm - Centre of Mixer to centre of Aerator
Connector Tails	Stainless Steel PEX Lined
Sink/Basin Mixer Operation	Swivel spout
Mixer Height	217mm - Bench to centre of outlet
Bench Fixing	Threaded Rod & Horse Shoe Bracket
Shut Off	35mm Ceramic Disc
Mount Surface Pressure	Suitable for up to 33mm bench thickness Hot and cold water inlet pressure should be equal Gravity feed not suitable

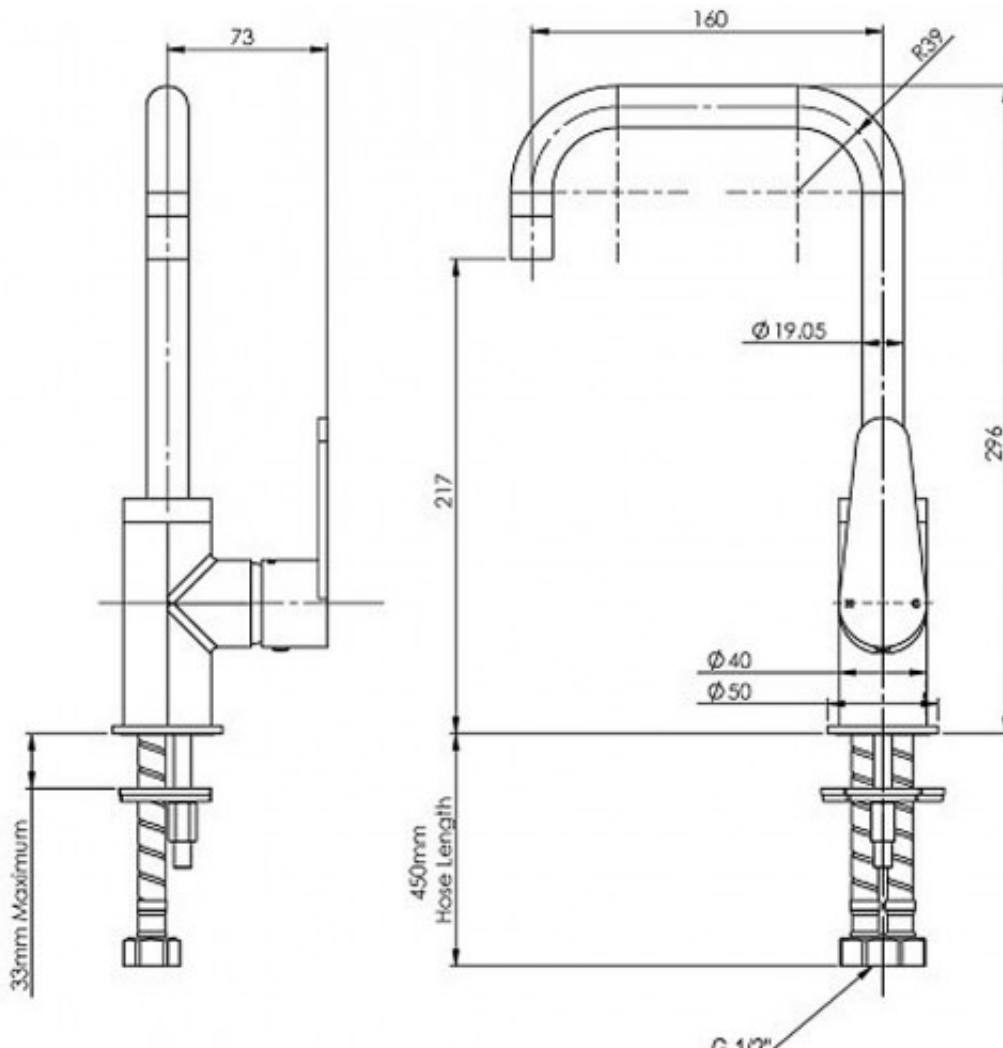

Printed:27/09/2020

© Raymor 2017. All rights reserved.

Version 1 1/09/2017

All measurements are in millimetres and are to be used as a guide only. Specifications and materials may change without notice. Whilst all care has been taken to ensure that all details are correct at the time of print we reserve the right to correct any errors, inaccuracies or omissions or to change or update any details or information at any time without notice.

*Subject to terms and conditions available at raymor.com.au

Raymor
more like you