

Features & Benefits

- 5 Star energy efficiency
- Mains pressure at multiple taps
- 50°C temperature limited models supply hot water at a maximum 50°C in accordance with AS 3498
- 275L first hour capacity of hot water
- Two anodes
- Natural gas model
- 10 year cylinder warranty¹

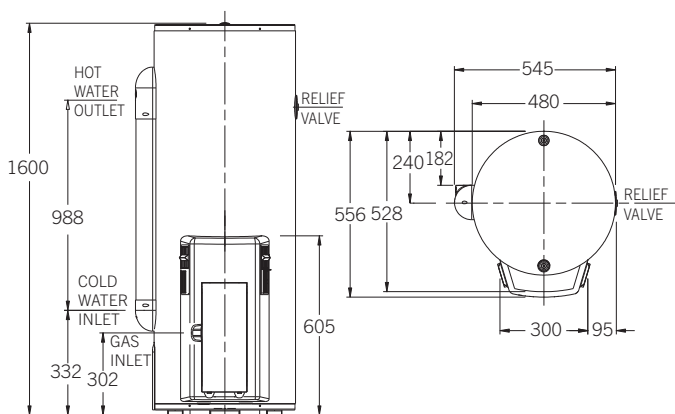

MODEL	854265
Storage Capacity (L)	130
Hourly Recovery (L)	145
Gas Consumption (MJ/Hr)	30
Relief Valve Pressure (kPa)	1400
Expansion Control Valve (kPa)	1200
Max Water Supply Pressure:	
with ECV (kPa)	960
without ECV (kPa)	1120
Water Connections	G 3/4
Gas Connection	Rp 1/2
Approx. Weight (packaged) kg	90



Scan code for details & installation instructions

