

## UNIVERSAL POP-UP WASTE

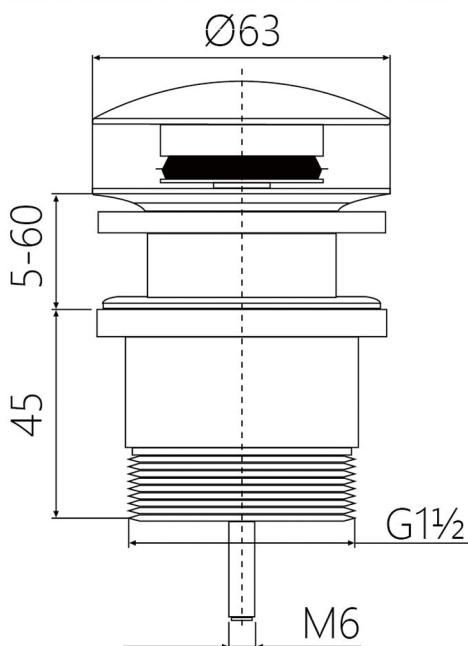





Dimensions are nominal measurements only.

## SPECIFICATION

PRODUCT CODE

A706

## FINISH

	NRA706CH	chrome
	NRA706MB	matte black
	NRA706GM	gun metal
	NRA706BN	brushed nickel
	NRA706BG	brushed gold

## MAINTENANCE AND CARE

All surfaces should be cleaned with mild liquid detergent or soap and water.

Do not use cream cleaners or citrus based cleaning products, as they are abrasive.

Use of unsuitable cleaning agents may damage the surface. Any damage caused in this way will not be covered by warranty.

## PACKAGING INCLUDES

- 1x pop-up waste
- 1x installation kit

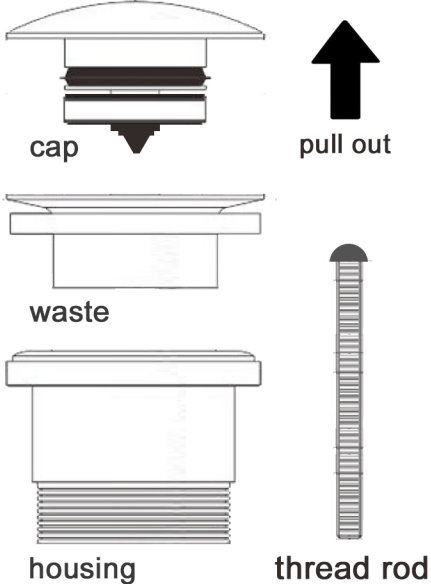
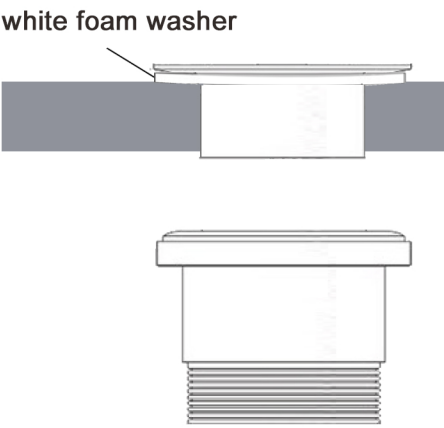
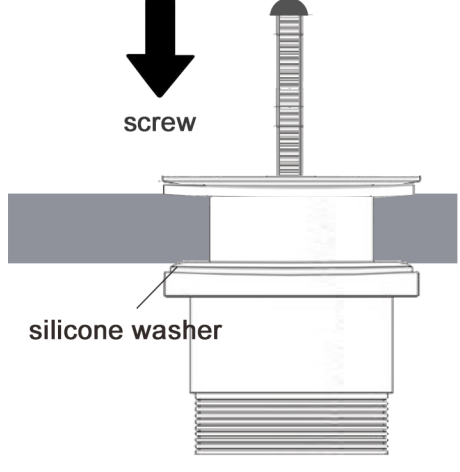
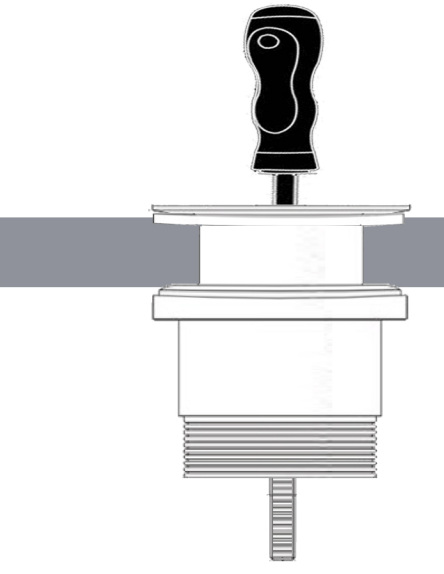
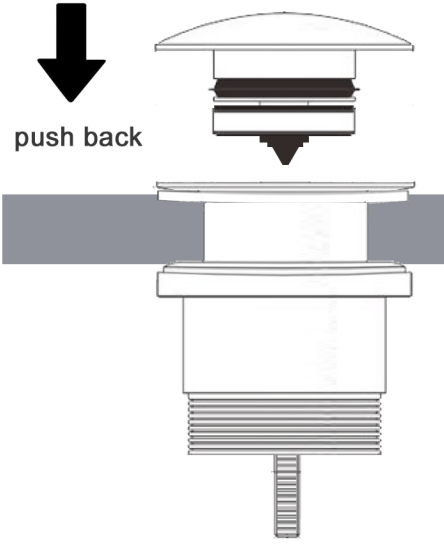
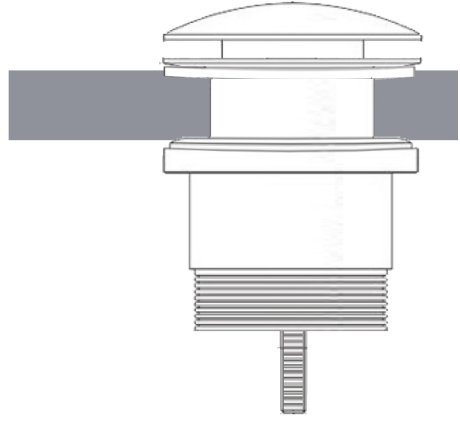

## INSTALL INSTRUCTION

 <p>cap</p> <p>pull out</p> <p>waste</p> <p>housing</p> <p>thread rod</p> <p>1. Disassemble pop-up waste by pulling out the cap and unscrewing the housing from the thread rod.</p>	 <p>white foam washer</p> <p>2. Put waste through in basin hole and make white foam washer fitted to upper side of the basin.</p>	 <p>screw</p> <p>silicone washer</p> <p>3. Put the housing covering on basin hole at bottom side. Screw thread rod through waste and housing in a row.</p>
 <p>4. Tighten up the thread rod by screw driver.</p>	 <p>push back</p> <p>5. Push back the cap.</p>	 <p>6. Finish, and check for leaks.</p>