

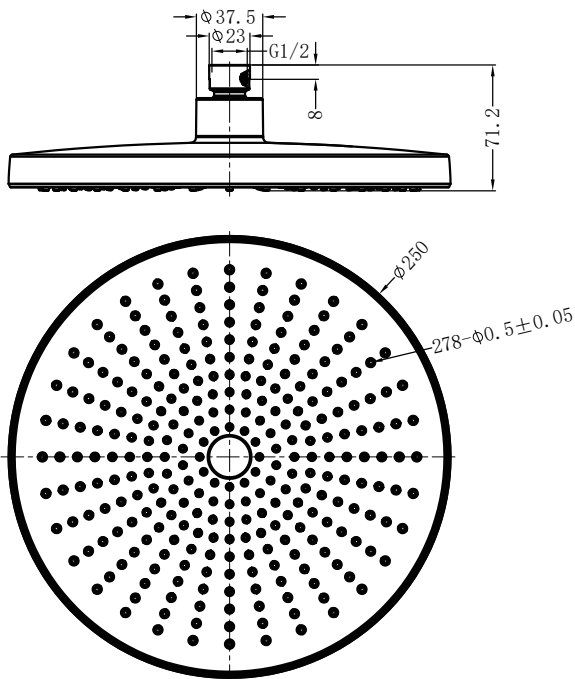

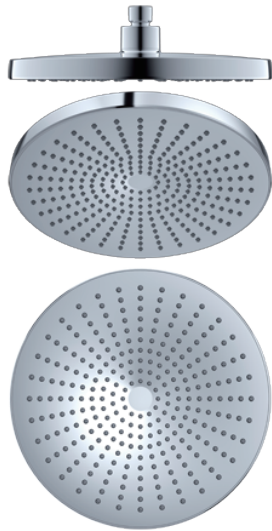



Shower Head



SPECIFICATION

| | |
|--------------------|-----------------------|
| PRODUCT CODE | 508079 |
| WELS RATING | 2Star 10.5L/Min |
| WATERMARK LICENSE | WM-060093 |
| TEMPERATURE RATING | Min 1°C-Max 75°C |
| PRESSURE RATING | Min 150KPa-Max 500Kpa |

AVAILABLE FINISH

| | | | |
|---|------------------------------|---|------------------------------|
|  | CHROME NR508079CH |  | MATTE BLACK NR508079MB |
|  | GRAPHITE NR508079GR |  | BRUSHED NICKEL NR508079BN |
|  | BRUSHED BRONZE NR508079BZ |  | BRUSHED GOLD NR508079BG |

MAINTENANCE AND CARE

All surfaces should be cleaned with mild liquid detergent or soap and water. Do not use cream cleaners or citrus based cleaning products, as they are abrasive. Use of unsuitable cleaning agents may damage the surface. Any damage caused in this way will not be covered by warranty.

PACKING INCLUDES

-1x shower head

