



Opal Rail Shower



SPECIFICATION

PRODUCT CODE	YSW2519-05A
WELS RATING	3Star 9L/Min
WATERMARK LICENSE	WM-060093
TEMPERATURE RATING	Min 1°C -Max 75°C
PRESSURE RATING	Min 150KPa-Max 500Kpa

AVAILABLE FINISH

	BRUSHED NICKEL NR251905aBN		BRUSHED GOLD NR251905aBG
---	-------------------------------	---	-----------------------------

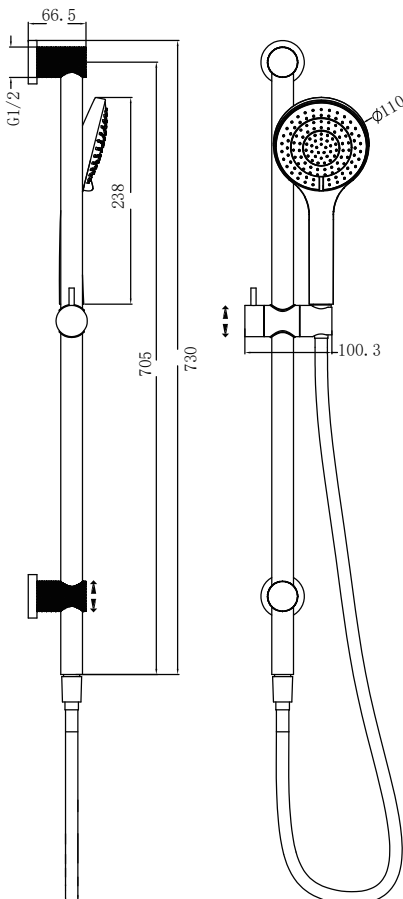

MAINTENANCE AND CARE

All surfaces should be cleaned with mild liquid detergent or soap and water. Do not use cream cleaners or citrus based cleaning products, as they are abrasive. Use of unsuitable cleaning agents may damage the surface. Any damage caused in this way will not be covered by warranty.

PACKING INCLUDES

- 1x hand shower (built-in check valve)
- 1x shower rail
- 1x adapter
- 1x shower bracket
- 1x 1.5m PVC hose
- 2x back plates
- 1x installation kit



Important

All products must be installed by licensed plumbers.

All pipework must be thoroughly flushed prior to installation, as foreign materials may block the flow regulating device and reduce the flow of water.

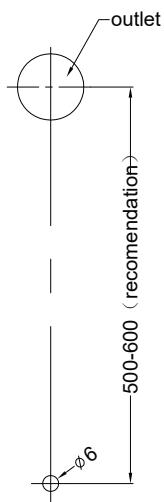

1. Drill a $\phi 6$ mm hole at the downwards outlet vertical downward position in the recommendation range.



2. Screw the adapter onto the outlet. Push wall plug into drilled hole. Fit lower mounting pillar in place with screw. Tighten firmly.

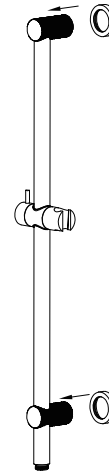

3. Slide both top and bottom back plate onto the rail assembly, as shown on the picture.

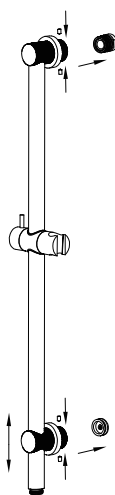

4. Push shower rail assembly onto the wall/tile face. Tighten grub screws firmly. Slide the back plates against the wall/tile face properly.

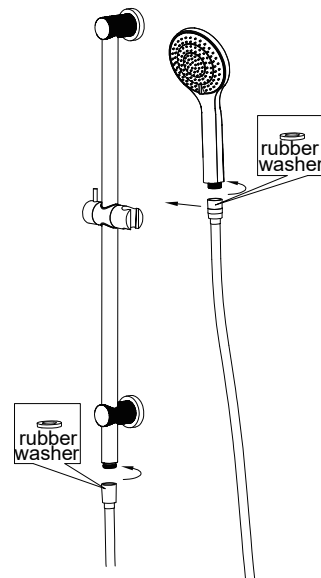

5. Connect shower rail and hand shower with hose. TEST & CHECK FOR LEAKS.