

Oliveri®

THIS DUAL SHOWER MUST BE INSTALLED BY A LICENSED PLUMBER IN ACCORDANCE WITH LOCAL REGULATIONS

This Oliveri dual shower is manufactured to standard AS/NZS 3662.

MAX OPERATING PRESSURE:.....5 bar (500kPa)
 RECOMMENDED OPERATION PRESSURE:.....1.5-5 bar (150-500kPa)
 MAX HOT WATER TEMPERATURE:.....65°C
 RECOMMENDED HOT WATER TEMPERATURE:.....50°

Where water pressure exceeds 500kPa, a pressure reducing device is required to be installed. Note that water pressure overnight can reach 150% of the daytime pressure.

Before attempting any work involving mains water supply lines, ensure the water supply is shut off. This dual shower must be installed in accordance with these instructions.

Oliveri®

CO10012MB



Copenhagen dual shower set MB

CARE & MAINTENANCE

Clean with a soft cloth and warm soapy water as necessary - rinse and dry after cleaning. Under no circumstances should abrasive or acid based cleaning products be used.

WARRANTY

This dual shower is warranted to be free from manufacturing defects for a period of 3 Years: 3 years for main body, 2 years for shower head, shower arm, plastic hand piece, hose, seals, o’rings, 1 year for finish and labour.

This warranty does not cover against normal wear and will be voided if the product is misused or not installed in accordance with these instructions.

In the event this product is rendered obsolete and a replacement product is required, Oliveri Solutions Pty Ltd reserves the right to supply a product of equal substitution at their discretion.

Our goods come with guarantees that cannot be excluded under the Australian Consumer Law. You are entitled to a replacement or refund for a major failure and for compensation for any other reasonably foreseeable loss or damage. You are also entitled to have the goods repaired or replaced if the goods fail to be of acceptable quality and the failure does not amount to a major failure.

SERVICE

If the problem represents a danger, or damage to property may occur, immediately shut off the water supply. If the product requires servicing, please contact your installer (preferably the one who installed it).

If the installer is satisfied that the problem is not due to poor installation, contact T2 Services Pty Ltd for assistance on:

Ph: (07) 5596 0738

Fax: (07) 5527 3353

Email: oliveri@t2services.com.au

<http://oliveri.com.au/service-and-warranty>

If a warranty service agent finds that the shower is not at fault, T2 Services Pty Ltd reserves the right to pass on any callout fee to the householder.

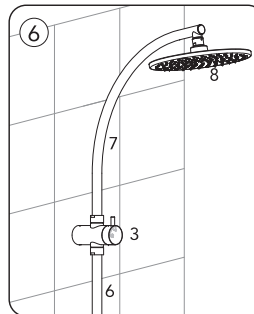
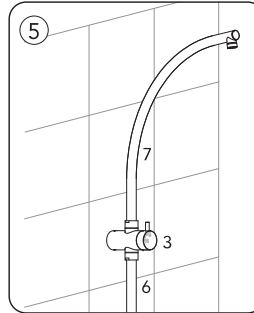
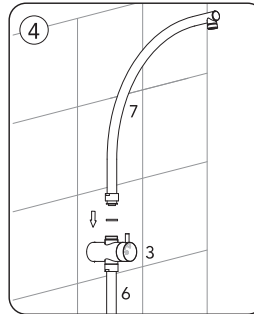
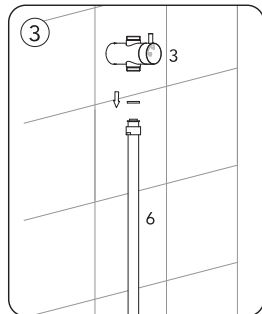
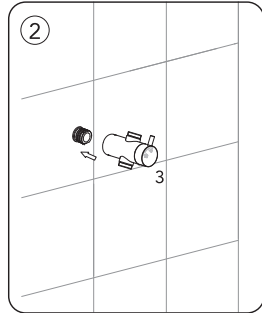
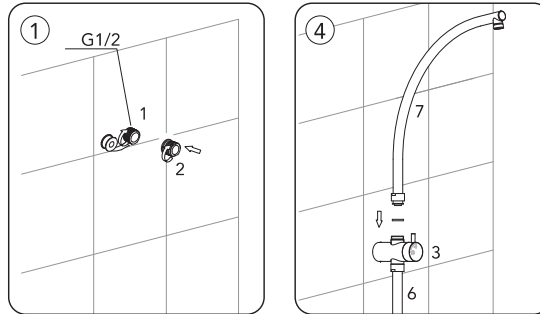
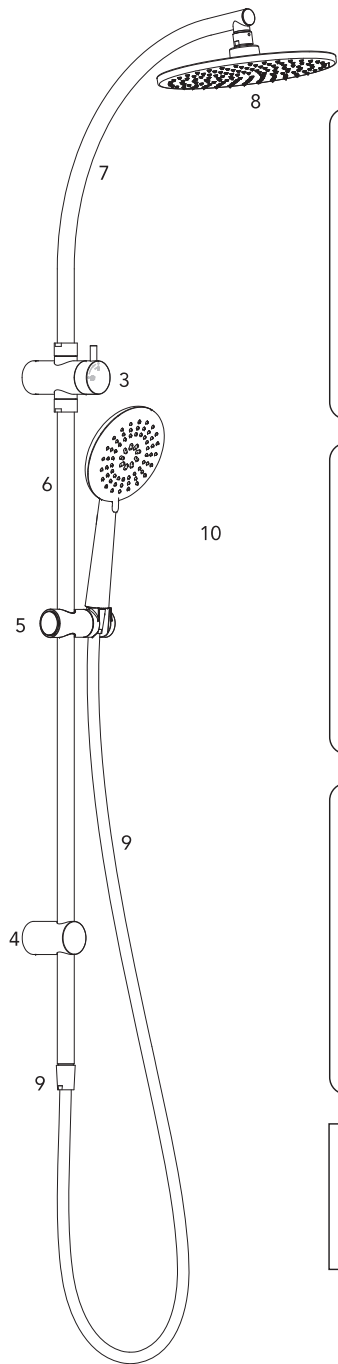

- | | |
|----------------------------|-----------------|
| 1. G 1/2 BSP Wall Outlet | 7. Shower Arm. |
| 2. Union | 8. Shower Rose. |
| 3. Main Body with Diverter | 9. Shower Hose |
| 4. Wall Support Bracket | 10. Hand Shower |
| 5. Centre Slider | |
| 6. Sliding Rail Tube. | |



Installation Instructions

Copenhagen Dual Shower

General Note: This product is to be installed by a licensed plumber, installation must comply with AS/NZS 3500 and local plumbing codes.

Pressures & Temperatures

Maximum Hydrostatic Pressure - 500 kpa. (Asper AS/NZS3500)

Note: AS/NZS 3500.1-2003 (Clause 3.3.4) states that "Provision shall be made to ensure that the maximum static pressure at any outlet, other than a fire service outlet, within a building does not exceed 500 kPa.

Note: Pressures above 500kPa can cause damage from water hammer, reduced life of appliances, taps and fittings, and cause excessive noise in the system.

Minimum Hydrostatic Pressure - 100 kpa

The Maximum operating temperature for the Shower is 65°C.

Please ensure that the lines are flushed prior to installation as contaminates in the water can damage the flow regulator and also affect the performance of the Shower.

1. Remove product from packaging and check for damages, if the product is damaged do not install and return to store of purchase.
2. The WELS compliant flow regulator has been pre-assembled in the shower head and hand piece inlet, to comply with WELS the flow regulators must remain in place.
3. Apply sufficient thread seal tape to the G1/2 BSP thread (1). (Do not overload thread with thread seal tape as this will put undue pressure on the shower union)
4. Screw the union (2) onto the G1/2 BSP thread and tighten with allen key supplied.
5. Push main body with diverter (3) over union (2) and lock into position by tightening the top and bottom grub screws with the allen key supplied.
6. Position wall support bracket (4) for sliding rail tube (6) approx 690 mm from the bottom of the Main Body (3) and pre-drill holes to suite the fixing screws supplied or suitable screws to suit material of wall.
7. Fix bracket (4) to wall.
8. Slide the pipe (6) downward through the center slide (5) and then through the wall bracket (4) to the bottom of the pipe lower than the bracket. Secure the tube (6) onto the bottom of the main body with diverter (3) .
9. Screw the end of the shower hose (9) with the small end onto the bottom of the tube - making sure the washer supplied is in position.
10. Screw the hand shower (10) onto the conical end of the shower hose (9) also making sure the washer and flow regulator supplied is in position and sit onto centre slider (5).
11. Secure the overhead shower arm (7) onto the top of the body with diverter (3) (if not already fitted).
12. Screw shower rose (8) onto the shower arm (7) making sure the washer and flow regulator supplied is in position.

To the consumer

1. The Shower is to only be cleaned with warm soapy water.
2. **Under No Circumstances** should any abrasive, cream or acid based cleaning agents be used as these types of cleaners will damage the finish, shower head nipples and seals.